

A WYOMING LANDOWNER'S HANDBOOK TO
Fences and Wildlife

*Practical Tips for Fencing
with Wildlife in Mind*

Second Edition
Revised and Updated 2015



WYOMING
WILDLIFE
FOUNDATION

Acknowledgements

Many resource and wildlife specialists, ranchers and landowners generously offered their insights and experience for this guide. The *Green River Valley Land Trust* (formerly *Wyoming Land Trust*) published the first 2012 edition of this handbook, *A Landowner's Guide to Fences and Wildlife*, under the guidance of Jordan Vana and Summer Schulz. The guide builds on my publication, *A Landowner's Guide to Wildlife Friendly Fences*, written for and published by Montana Fish, Wildlife and Parks, and used with permission. This new Wyoming edition is revised and updated, benefitting from the creative ideas and practical experience of landowners and resource managers who have adopted a wildlife friendly approach in their operations.

The *Wyoming Wildlife Foundation*, a priority area of the *Wyoming Community Foundation*, provided funding for the first edition and spearheaded this update, with the oversight of Nic Rogers. Many others helped make this new edition possible, including *Jackson Hole Wildlife Foundation*, *Janet Marschner*, *The Meg and Bert Raynes Wildlife Fund*, *National Parks Conservation Association*, *Sublette County Conservation District*, *Teton Conservation District*, *Tronox Alkali*, and *Western Landowners Alliance*.

A special thanks to everyone who contributed insights, research, photographs and manuscript reviews. Joel Bousman, John Nunn, Steve Pokorny, Don Spellman, Lindsay Wood, *Wyoming Wildlife Foundation* and *Tronox Alkali* shared their experiences for the first-hand stories found throughout the document. My thanks to Ed Jenne for his illustrations and to Nancy Seiler for her creative talent in layout and design. Any errors in this booklet are mine alone.



Mark Goeke

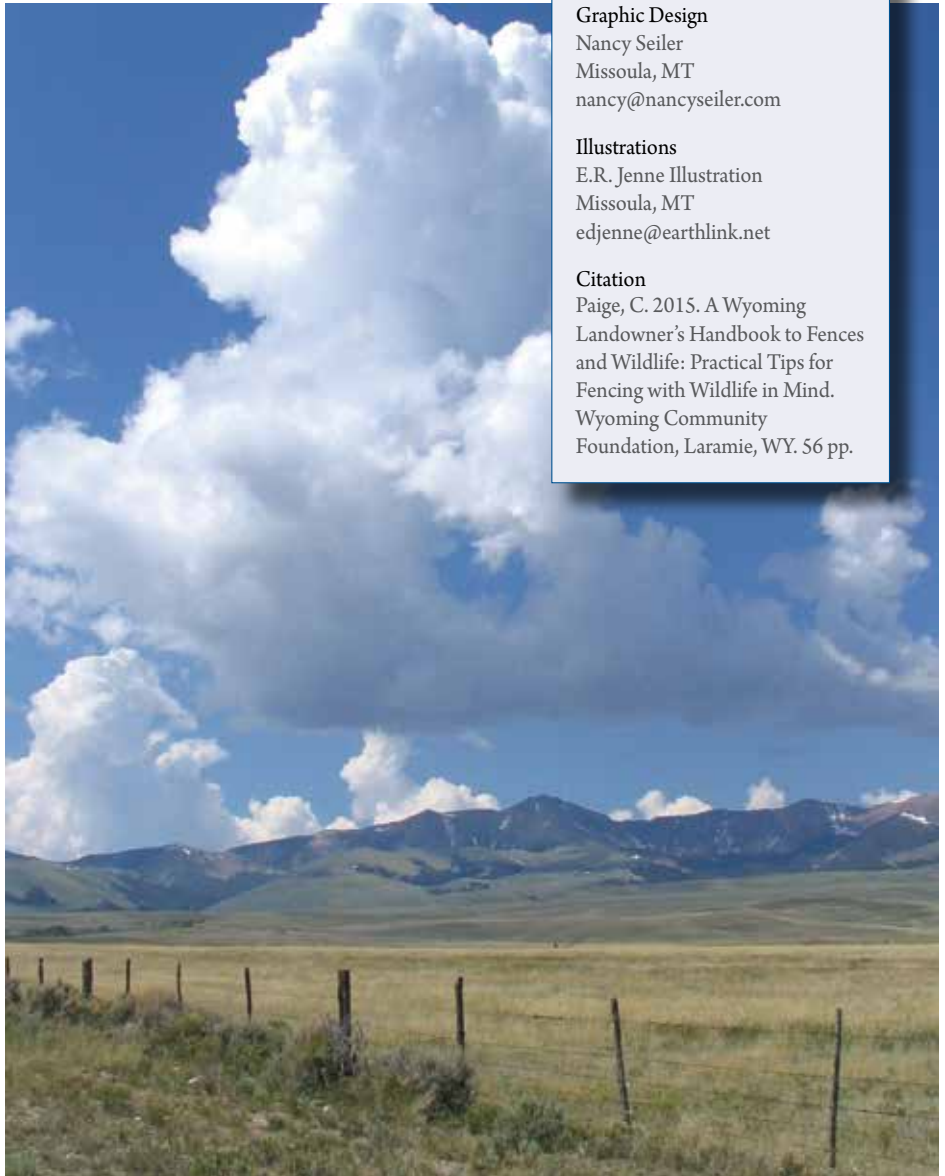

Christine Paige

Author

Christine Paige
Ravenworks Ecology, Driggs, ID
chrispaige@gmail.com

Graphic Design

Nancy Seiler
Missoula, MT
nancy@nancyseiler.com

Illustrations

E.R. Jenne Illustration
Missoula, MT
edjenne@earthlink.net

Citation

Paige, C. 2015. *A Wyoming Landowner's Handbook to Fences and Wildlife: Practical Tips for Fencing with Wildlife in Mind*. Wyoming Community Foundation, Laramie, WY. 56 pp.



©Henry H. Holdsworth/wildbynaturegallery.com

Wildlife and Fences	4
Problem Fences	5
Wildlife Friendly Fences	8
Getting Started	8
Fence and Crossing Placement	9
Friendly Designs	10
A Friendlier Fence.....	10
Visibility	12
Sites with Low or Seasonal Livestock Use	16
Sites with High or Continuous Livestock Use	23
Openings, Crossings and Passes	29
Remedies for Existing Fences	39
Residential Fences	44
Fence Alternatives	45
If You Must Exclude	47
Deterring Predators	51
Getting Help	54
Sources	55



Christine Paige



Mark Gocke

Why build wildlife friendly fences?

Countless miles of fence crisscross the West like strands of a spider's web. Fences are important for controlling livestock and trespass. They define and separate ranches and farms, outline property boundaries, enclose pastures and rangelands, and prevent livestock from straying onto highways.

Yet those miles of fence can also create hazards and barriers for wildlife, from big game animals to birds. Fences can block or hinder daily wildlife movements, seasonal migrations, and access to forage and water. Wildlife may avoid areas with too many fences to negotiate – for example, pronghorn choose seasonal ranges with lower fence densities (Sheldon 2005.) When animals collide or tangle in fences they can be injured or killed, and wildlife damage to fences can be costly and frustrating for landowners.

MANY WILDLIFE FRIENDLY FENCE DESIGNS ARE EASY AND LOW-COST, OR SAVE MONEY BY REDUCING FUTURE FENCE REPAIR.

Yet not all fences create problems for wild animals. By tailoring fence design and placement, you can prevent wildlife injuries and decrease damage to your fence. Many of these methods are low-cost or can save money in the long-run by reducing the need for future fence repair.

This guide will help you construct and modify fences and crossings that are friendlier to wildlife while still meeting fencing needs. It will also help you with sources for technical assistance and possible cost-share opportunities.

Fence Law in Wyoming

A "Fence Out" State:

By law, Wyoming is a "fence out" state, which means that landowners are responsible for protecting their own property from ranging livestock. A stock-owner is not liable for trespass or damage if a property is not adequately protected by a "lawful fence."

The fence out rule applies to cattle and domestic bison, but Wyoming is a "fence in" state for sheep. This custom has deep roots in Wyoming's history due to ranching traditions and the large areas of open range in the state.

Generally, a lawful fence is a fence constructed well enough to keep out livestock. Wyoming Statute §11-28-102 stipulates that 3-strand barbed wire, board, pole or rail fence are all acceptable, and the statute provides some examples and specifications.

In addition, however, Wyoming Statute §11-28-102(b) states: "All other fences made and constructed of boards, rails, poles, stones, hedge plants or other material which upon evidence is declared to be as strong and well calculated to protect enclosures, and is as effective for resisting breaching stock as those described in subsection (a) of this section, shall be considered a lawful fence."

Posting Against Trespass:

Wyoming Statute §6-3-303 provides that notice of trespass is given by "posting of signs reasonably likely to come to the attention of intruders."

While many states stipulate the use of orange paint on fence posts or tree trunks to designate no hunting or trespass, there are no specific regulations in Wyoming regarding marking against trespass in this manner.

Other Regulations

Check with your county and city offices for any local ordinances or regulations specific to fencing. If your property adjoins a state highway, check with Wyoming Department of Transportation (WYDOT) regarding highway right-of-way fence and options for removing or modifying fence for wildlife.



Problem Fences

Although deer, elk, moose, mountain sheep, and pronghorn are all capable of jumping fences, in a variety of situations they can become injured or entangled. Wire strands can readily snag animals and tangle legs, especially if wires are loose or spaced too closely together.

Animals can be hindered by deep snow or steep slopes, and young, pregnant or winter-stressed animals may have a particularly difficult time clearing fences. Deer, elk and other wildlife often bear scars from wire barbs. A torn ligament, strained leg or infection can weaken an animal's chance of survival, and if animals can't pull free at all, they slowly die of trauma and dehydration.



Cory Lovelace

Some fences, especially woven wire fence, can be a complete barrier to fawns and calves even if adults can still jump over. Separated from their mothers and stranded from the herd, the youngsters curl up and die of exposure and dehydration. Woven wire can snare and strangle medium-sized animals and livestock if they push their heads through the wire mesh, and may block animals such as bears and bobcats that are too large to slip through.

If woven wire is topped with one or more strands of barbed wire, the fence

becomes a complete barrier, especially for fawns, calves, pronghorn and other animals that are incapable or unwilling to jump over such a fence. Animals trying to leap a woven wire/



Colorado Parks and Wildlife file photo

WINTER-STRESSED, PREGNANT AND YOUNG ANIMALS MAY ESPECIALLY HAVE TROUBLE CLEARING FENCES. AN INJURY OR INFECTION FROM TANGLING WITH FENCES CAN WEAKEN AN ANIMAL'S CHANCE OF SURVIVAL. IF ANIMALS CAN'T PULL FREE AT ALL, THEY DIE OF TRAUMA AND DEHYDRATION.

barbed wire fence are even more likely to tangle a leg between the top barbed wire and the stiff woven wire. In urban areas, fences topped with barbs or pointed spikes, such as decorative iron fences, can trap or impale leaping deer and other animals.

Large, low-flying birds, too, may collide with fences and break wings, impale themselves on barbs, or tangle in wires. Ducks, geese, cranes, swans, grouse, hawks and owls are especially vulnerable. Waterfowl fly into fences that run near or across waterways, and hawks and owls may careen into fences when swooping in on prey.



Mark Gocke



Sheila Lamb

Problem Fences



Jack Jones



Jeremy Roberts, Conservation Media



Tom Campbell

What kinds of fence cause problems for wildlife?

Fences that:

- are too high to jump;
- are too low to crawl under;
- have loose or broken wires;
- have wires spaced too closely together;
- can impale or snag a leaping animal;
- are difficult for running animals or birds to see;
- create a complete barrier.



Doug Wood

Above: This peregrine falcon died when it collided with a fence while diving on killdeer. Many birds are vulnerable to fence collisions.



Chris Mayne

Above: After crossing a highway, a black bear desperately searches for a way through a woven wire fence, finally climbing a power pole to leap over.



Tom Koenig, Colorado Parks and Wildlife



The Bottom Line: Hard Numbers

Recently, researchers at Utah State University completed a study of wildlife mortality along more than 600 miles of fences in the rangelands of northeastern Utah and northwestern Colorado (Harrington 2005, Harrington and Conover 2006). By repeatedly driving and walking fencelines over two seasons, they tallied the number of mule deer, pronghorn and elk carcasses they found caught in fences and lying next to fences. They also studied which fence types caused the most problems.



The Jackson Hole Guide

Here are their key findings:

Snared and Entangled

- On average, one ungulate per year was found tangled for every 2.5 miles of fence.
- Most animals (69% of juveniles and 77% of adults) died by getting caught in the top two wires while trying to jump a fence.
- Juveniles are 8 times more likely to die in fences than adults.
- Mortalities peaked during August, when fawns were weaned.
- Woven wire fence topped with a single strand of barbed wire was the most lethal fence type, as it easily snared and tangled legs between the barbed wire and rigid woven wire.
- 70% of all mortalities were on fences higher than 40".



Steve Primm

TIP:

IF TRYING TO RESCUE A TANGLED AND STRUGGLING ANIMAL, COVERING ITS HEAD WITH A CLOTH OR COAT WILL HELP CALM THE ANIMAL.

Above: This badly tangled pronghorn was fortunately freed by the photographer, who was able to clip the wires.



Bryce Andrews

Elk, deer and other ungulates often die if their legs tangle in wire fences. Woven wire topped with barbed wire was found to be the most lethal type of fence, especially for young wild ungulates.

Blocked and Stranded

- Where ungulates were found dead next to, but not in fences, on average one ungulate per year died for every 1.2 miles of fence.
- 90% of these carcasses found near fences were fawns lying in a curled position – probably separated from their mothers when they could not cross.
- Most of these indirect mortalities were found next to woven wire fences.



Randy Gazda



Tim Stevens

Antlered animals can become fatally tangled in poly rope fence and loose barbed wire. Maintaining fence tension and using high-tensile wire for electric fences prevents such losses.

Getting Started

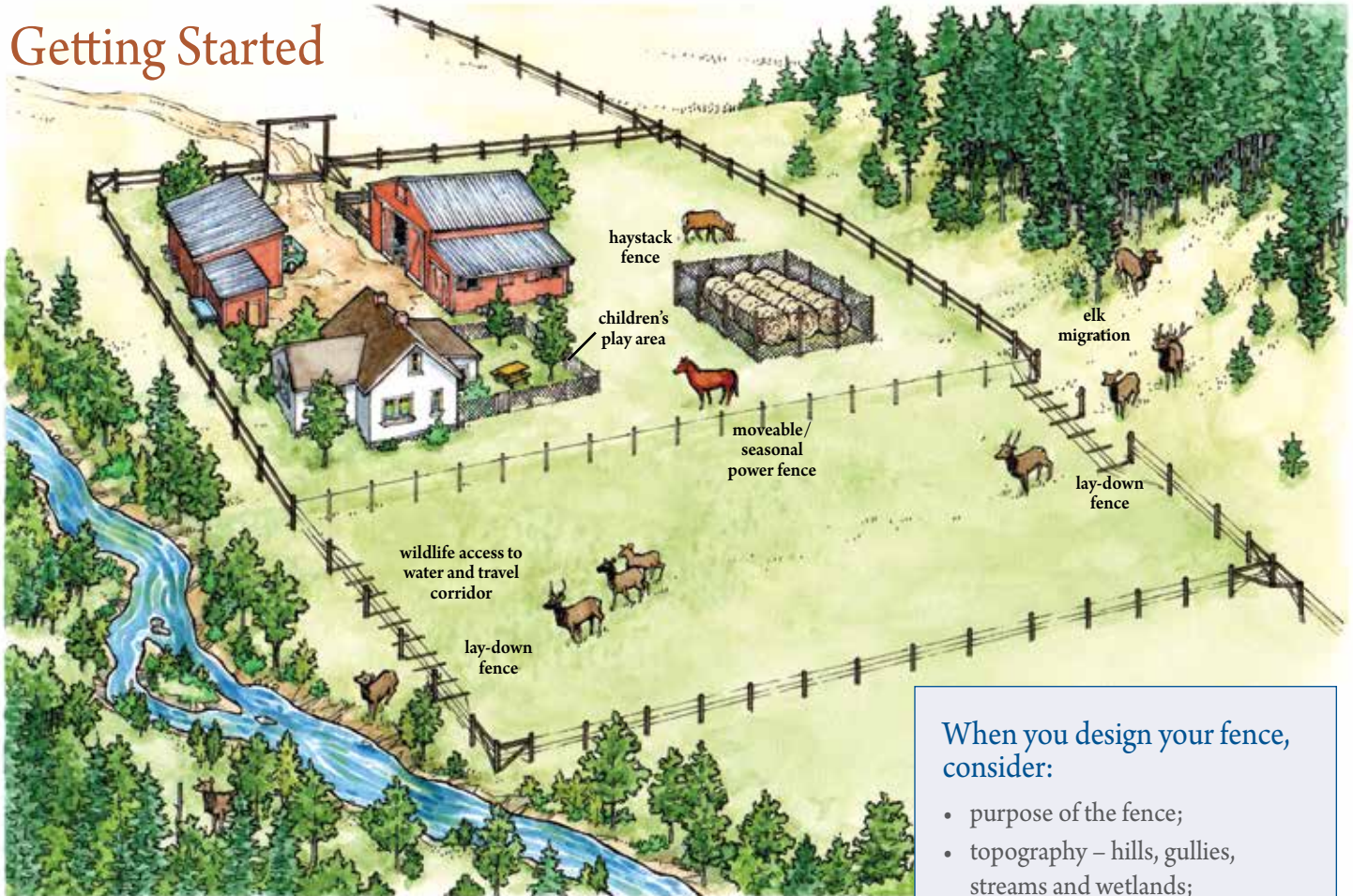

The best situation for wildlife is open habitat with no fences at all. Wherever possible, remove obsolete fences that are no longer needed.

Where you need to fence, less fence is better. Established fences can be modified to allow easier passage, and new fence can be designed with wildlife in mind.

To get started, consider your needs and create a plan. You can tailor any of the designs in this guide to your specific needs.

First consider these questions:

1. What is the purpose of the fence?

Do you need to mark a boundary? Deter trespass? Enclose or exclude livestock? If your fence is for livestock, what kind, in what seasons, and for how long?

Your purpose should determine your fence design and placement.

2. What is the topography?

Are you fencing on hills, in rocky country where posts cannot be driven, or near or across streams or wetlands? *Design your fence to avoid creating traps for wildlife.*

3. Which wildlife species are in your area?

Build fence or crossings that both young and adult animals can negotiate.

When you design your fence, consider:

- purpose of the fence;
- topography – hills, gullies, streams and wetlands;
- species of wildlife present;
- daily or seasonal wildlife movements in the area;
- presence of water, food and cover for wildlife;
- presence of young animals.

4. What are the daily or seasonal wildlife movements in the area?

Do animals calve or nest nearby? Does wildlife migrate through to winter or breeding areas?

Allow movement and access through natural corridors and habitats.

MOST FENCES CAN BE DESIGNED OR MODIFIED TO ALLOW EASIER PASSAGE FOR WILDLIFE.



Fence and Crossing Placement

Placement of fences is just as important as the type of fence used.

Fencing need not restrict wildlife movement everywhere on your property. Wherever possible, design your fence to provide wildlife free travel to important habitats and corridors, as well as access to water. Wetlands and riparian habitats are especially important for all wildlife.

Watch for daily and seasonal wildlife movement patterns and look for trails. Use impenetrable, special purpose fence only in specific areas where it is critical, such as calving or lambing pastures, haystacks, gardens, orchards, play areas or kennels.

Design property boundary fence so wildlife can easily cross, or with gaps or lay-down sections for wildlife passage whenever and wherever livestock are not present.

Work with your land's topography. Swales, gullies, ridges and stream corridors can funnel wildlife through an area – keep these open to allow wildlife passage and avoid topography traps.

A fence of any height is more difficult to cross when placed across a steep slope or next to a deep ditch. As ground slope increases, the height



Christine Paige

Tailor your fences to specific needs and allow wildlife access to water, important habitats, and travel corridors.



Christine Paige

Good Fence Placement Tips

- Look for wildlife trails and watch for seasonal patterns.
- Provide wildlife access to riparian habitats, water holes and other high quality habitats.
- Provide passage along swales, gullies, ridges and stream corridors.
- Use the appropriate fence design for each activity.
- On slopes and in natural travel corridors, plan for wildlife crossings.

effective fence height to 48.6"; a slope of 30% increases effective height to 62", and on a 50% slope animals encounter an obstacle 75" high. **Fences on steep slopes become nearly impossible for animals to jump without injury.**

SLOPE INCREASES BARRIER

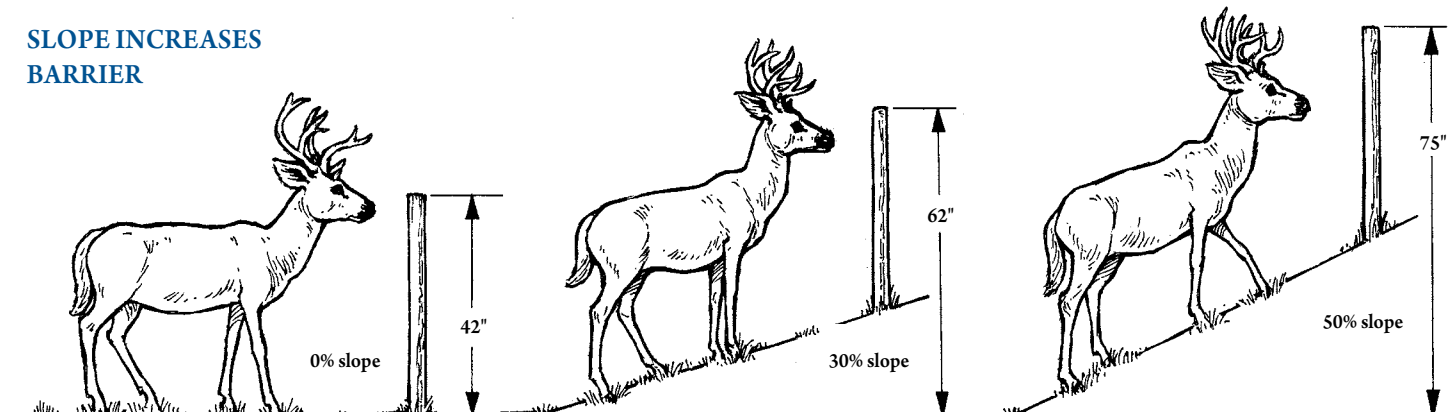

A Friendlier Fence

A fence that is friendly to wildlife should:

- Allow animals to jump over and crawl under easily without injury;
- Be highly visible for both ungulates and birds.

You can combine or tailor many of the ideas presented in this guide for your specific situation.

The top wire or rail should be low enough for adult animals to jump over, preferably 40" or less, and no more than 42" high. The distance between the top two wires should be no less than 12" apart. Deer and elk easily tangle their back legs if the top wires are closer together.

The bottom wire or rail should be high enough for pronghorn and young wild ungulates to crawl under. The bottom wire should be a minimum of 16" from the ground and preferably at least 18." Take advantage of small dips, swales and gullies to provide a slightly larger gap below the fence and allow animals to pass under easily. Many cattle ranchers have found that although a small calf may slip under the higher bottom wire, they can also easily slip back again to mom and not be stranded on the wrong side of the fence.

ALTHOUGH CALVES MAY SLIP UNDER A HIGHER BOTTOM WIRE, THEY CAN ALSO SLIP BACK AGAIN TO MOM, AND NOT BE STRANDED.

Increasing visibility using a top rail, high-visibility poly-wire, flagging or other markers can help ungulates and birds better avoid or navigate fences. Using smooth wire – such as barbless twisted wire – for the top and bottom strands will prevent snagging and injuries.

Use electric tape or braid only for temporary applications. It should be removed or lowered to the ground when livestock are not present.

In some situations, fence stays can help maintain distance between strands,

prevent sagging, and reduce the chance of entanglement. However, wire stays are easily bent over, collapsing the fence and creating a three-dimensional hazard, and need to be regularly maintained. An alternative is a stiff plastic or composite stay or fiberglass post that flexes but maintains its shape.

In wildlife migration areas, drop-down fence, lay-down fence or other crossings can be incorporated into fence sections for seasonal wildlife passage. **Good husbandry practices go hand in hand with wildlife friendlier fences. Livestock that have good forage and the security and companionship they want are much less likely to test or challenge fences.**

The Wildlife Friendly Fence: A Livestock/Wildlife Compromise

These standards will control cattle in most situations and allow for easier wildlife passage.

Fences should be low enough for adult animals to jump, high enough for wildlife to crawl under, and minimize the chance of tangling. We recommend:

- A top wire or rail preferably no more than 40" and a maximum of 42" above the ground;
- At least 12" between the top two wires;
- A bottom wire or rail at least 16" and preferably 18" above the ground;
- Smooth wire or rail for the top, smooth wire on bottom;
- Preferably, no vertical stays. If used, consider stiff plastic or composite stays, or regularly maintain wire stays that are easily bent;
- Posts at 16.5-foot intervals;
- Gates, drop-downs, or other passages where wildlife concentrate and cross.

A FRIENDLIER FENCE FOR WILDLIFE

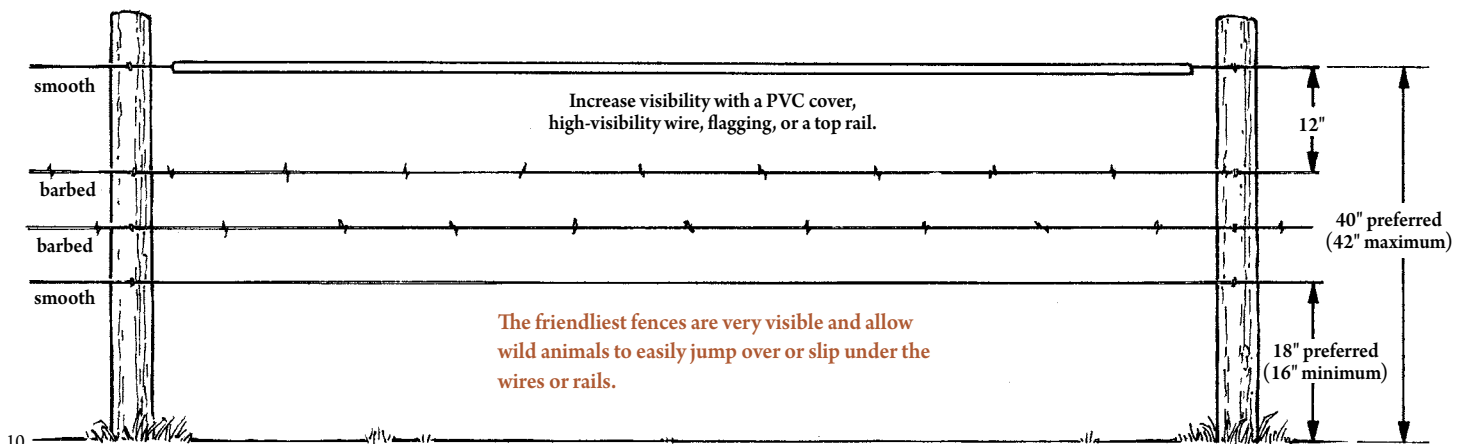

FENCE SOLUTIONS PUT TO THE TEST

Going Wildlife Friendly at Eastfork Livestock

Located thirteen miles south of Boulder, Wyoming, on the western flank of the Wind River Range, Eastfork Livestock is owned and managed by Joel Bousman and his family. The family's deep roots in the area run back to Bousman's grandfather, who homesteaded on the East Fork River, and forward to his grandchildren, the sixth generation to live here.

The family runs a 500-head cow/calf operation on a diverse mix of private ranch land, leased state land, and BLM and Forest Service grazing allotments. The operation stretches from valley sagebrush shrub-steppe and flood-irrigated native grass hay meadows up to montane and alpine meadows.

Bousman has long been committed to balanced use and science-based stewardship, basing his resource decisions on careful monitoring of conditions. He initiated a cooperative monitoring program among the several permittees on the Silver Creek grazing allotment, and organizes annual monitoring rides with Forest Service, BLM, Game and Fish and NRCS personnel to identify issues and management objectives.

When Bousman learned of the Green River Valley Land Trust's (formerly Wyoming Land Trust) initiatives to install wildlife friendly fences in pronghorn and mule deer migration corridors of Sublette County, he was intrigued. "I always thought that wildlife friendly meant 3-wire smooth wire fence and that wouldn't work for cattle," he explains. "Then I was on a land tour and saw this style of fence and thought, well, that would work for us."



Tracks reveal where mule deer now easily cross Eastfork Livestock's new wildlife friendly fence. Twelve inches between the top two wires, a smooth bottom wire placed at least 16" high, and a top wire no more than 42" high make a friendly fence.

Christine Paige



Joel Bousman points out where mule deer readily cross his cattle fence that was modified for wildlife.

Christine Paige

With the aid of the GRVLT, Bousman replaced twelve miles of fence with a wildlife friendly design, using a standard of 42" top wire, a smooth wire on the bottom at 16" and a 12" spacing between the top and second wire to reduce the chance of animals tangling

their legs as they jump over. Fence posts and wires were replaced wherever needed, and otherwise the fence was modified using existing materials as long as they were in good shape.

Pointing out tracks in the early winter snow, Bousman observes, "You can see where the mule deer easily jump over and go under the fence." Asked about the dimensions of the fence, Bousman says it works well for his cattle, and with the bottom smooth wire at 16" height, he isn't worried about his calves. "The only thing that might get through are the really little ones, and not for long – they want to stick close to mom."

Two mule deer found no trouble in crossing an Eastfork Livestock wildlife friendly fence.

Photo: Christine Paige





Christine Paige



Jay Kolbe

Visibility

Running animals and low-flying birds may not see a wire fence clearly against the landscape. Making a fence highly visible prevents collisions, and can help animals judge the height of a fence for jumping.

One solution is a top rail. A rounded rail will shed snow more easily: heavy snow buildup can sometimes deter elk and deer from crossing. For wire fences, an inexpensive modification is to slip small diameter PVC pipe over the top strand. Note, there is some evidence that white PVC may instead deter pronghorn and deer, and it would be worthwhile to test animals' reaction to a PVC cover in known crossing spots.

Smooth wire fences, especially high-tensile wire, may be essentially invisible to animals. These can be made more visible by adding fence markers or highly visible polywire or polytape on the top strand. Twisted barbless cable is more visible than a single wire strand, and

high-visibility wire is available in many forms – tape, braid and polymer-coated wire – which can be electrified if needed. White wire is the most visible in summer, but black and white wire or tape makes the fence more visible against both summer vegetation and snow.

High visibility helps animals avoid and negotiate fences. It is especially important in grasslands and near creeks and wetlands to protect low-flying birds, such as grouse, owls and swans. Rails, PVC pipe, flagging, or black and white wire or tape can all make fences more visible.



Montana Fish, Wildlife & Parks



Fence Flags for Grouse and Other Birds

Fence flags or markers dramatically increase visibility of wire fences for wildlife, especially birds, and help animals avoid and negotiate fences.

RESEARCH ON SAGE-GROUSE IN WYOMING, IDAHO AND MONTANA HAS SHOWN THAT FENCE MARKERS CAN REDUCE FENCE COLLISIONS BY 70% TO MORE THAN 80%.

Research on sage-grouse and other prairie grouse has shown that fence collisions are common and widespread, especially near breeding areas.

Grouse fly fast and low into their mating areas (called “leks”) just before dawn and, in the dim light, are vulnerable to colliding with nearby fences.

However marking fence for visibility can dramatically reduce collisions by 70% to 83% (Christiansen 2009; Stevens et al. 2012b.) (*continued*)



Mark Goette

Markers for Wire Fence

For barbed or woven wire fence:

- Cut several 12' strips of “undersill” or trim strips of white vinyl siding, available at home hardware centers.
- Cut strips to 3" pieces. Use tin snips for small projects, or use a 10" miter saw with a 200-tooth blade to cut up to 16 pieces at a time for larger projects.
- One 12' siding strip yields 48 pieces.
- For extra visibility, add reflective tape to both sides of the markers, which increases detection in low light. Or use both black and white markers for visibility against snow and vegetation.
- Snap pieces onto fence wires – they are held in place between barbs.

Wyoming Game and Fish has found that, for each rod of fence, a minimum of two pieces with reflective tape on the top wire is effective. Or, alternate four pieces of black and white markers on the top wire. Marking a lower or bottom wire will increase visibility for pronghorn and other wildlife.

For smooth wire fence:

- To keep the vinyl siding markers from sliding, crimp a ferrule, twist a small spring, or tighten a UV-resistant zip-tie (tie-wrap) onto the wire on each side of the marker. Although this adds time to installation, it keeps the markers in place. Crimping the marker itself causes the marker to wear and break.
- An alternative is to make flags from reflective tape that can adhere to the wire (note, however, that reflective tape will conduct power on a hot wire.)
- Some commercially-made markers available online or in ranch supply outlets may work better on smooth wire.
- Place a minimum of two flags per rod of fence on the top wire; or up to four on the top wire and three on the middle or bottom wire.



Jeremy Roberts, Conservation Media

Visibility (continued)

Not every mile of fence needs to be marked for grouse. Marking is most important where there are high densities of birds: within 1.2 miles of a lek and in wintering areas. Also, sage-grouse are most vulnerable to collisions in open, flat or rolling country, and in areas with more fences (>1.5 miles of fence per square mile; Stevens et al. 2012a, 2012b.)

A relatively inexpensive and durable marking technique uses 3" flags cut from vinyl "undersill" or trim siding strips. The undersill siding has a lip that can be snapped onto barbed wire fence, with the barbs keeping the markers from sliding.

As an alternative, commercially produced fence markers can be purchased through a number of retail and mail order outlets.

For example, the Firefly Diverter at www.fireflytechproducts.com has UV-visible reflective tape. Fly Safe at www.flysafellc.com works on barbed wire. The See-A-Fence marker at www.knifedgedellc.com/seeafence.html works on smooth wire fence.

While marking the top wire only is effective for grouse, adding markers to lower wires may also help pronghorn and other wildlife that slip under fences.

Durable and lightweight fence markers can be cut from strips of vinyl siding trim. The trim strip has a lip that easily snaps onto fence wires.



Tom Christiansen



Bruce Waage



Christine Paige

DURABLE MARKERS ON WIRE FENCE

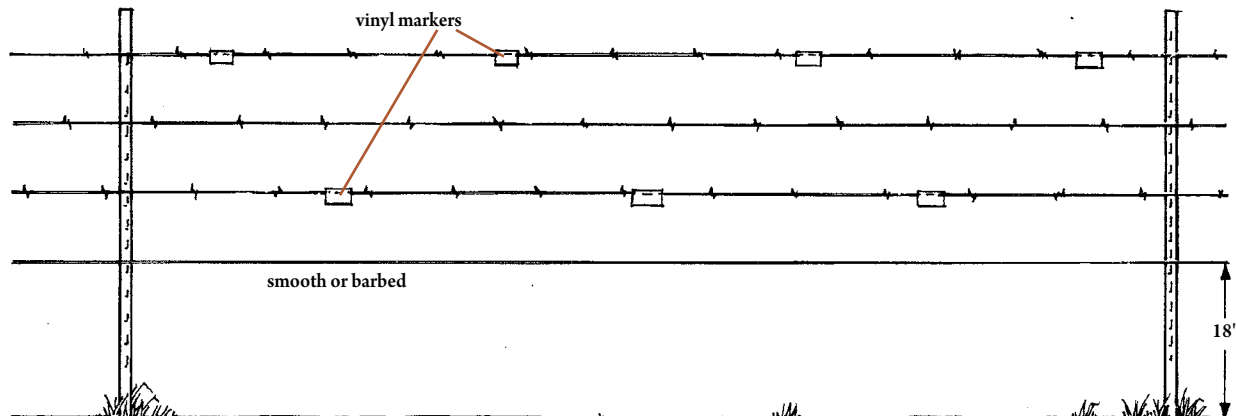

FENCE SOLUTIONS PUT TO THE TEST

Joining Forces for Migrating Wildlife

Snap...snap...snap: young hands clip vinyl fence markers onto fence wires. On an early June day, algebra students from Pinedale High School are out placing markers on barbed wire fences, the better for sage-grouse to avoid colliding with fences on their pre-dawn flights to their mating grounds. The class spent the semester learning how algebra applies to real-world problems, calculating how many markers and volunteers were needed to mark fences for grouse on the nearby highland simply called The Mesa. Then they made it real, marking five miles of fence to help protect birds, while double-checking their numbers.

The sagebrush flats of the Mesa, just south of Pinedale, are not only a year-round home for sage-grouse, but the winter destination of thousands of mule deer and pronghorn that migrate from summer ranges in the Gros Ventre and Wind River mountains—some of the longest migrations recorded in Wyoming. Yet what was historically ranch country has seen intense development for oil, natural gas, and homes over the past decade, resulting in worrisome declines of wildlife numbers.



Near Pinedale, Wyoming, community members, conservation groups, industry and resource agencies collaborated to improve miles of fence for wildlife.

Barbed-wire fences can be a hazard for mule deer, pronghorn, and grouse. So local agencies, community groups and landowners came together to modify miles of fence that crisscross the Mesa and reduce the risk to wildlife. Partners and funders included the Wyoming Wildlife Foundation (WWF), Green River Valley Land Trust (GRVLT), BLM, Wyoming Game & Fish Department, Wyoming Department of Agriculture, the Wyoming Wildlife and Natural Resources Trust, Mule Deer Foundation, the Muley Fanatics Foundation and other corporate and private funders.

In 2012, GRVLT inventoried 91 miles of fence, and then brought together WWF and other cooperators to help modify 77 miles of fence over three years to wildlife friendly standards. Dilapidated wire was replaced with new wire, and posts replaced where needed. Wire heights were set at 42" for the top; a 12" spacing between the top and second wire to help prevent legs from tangling, and a 16" bottom smooth wire so pronghorn can slip under more easily.

In addition, WWF and their partners marked a total of 14 miles of fence that posed a hazard for sage-grouse in core habitat on the Mesa. They involved not only the Pinedale High School math class, but also other student groups. Medicine Bow Future Farmers of America, a 4-H Club and a local Boy Scout troop received funds from Natural Resources Conservation Service (NRCS) to make the thousands of markers needed by cutting up strips of vinyl undersill siding. Now the white flags allow grouse to sail smoothly over fences as they gather on their dancing grounds each spring to ensure a new generation.

Photo: Christine Paige



Sites with Low or Seasonal Livestock Use

Not all situations require a 5-strand barbed wire or a woven wire fence. Many situations with low or seasonal livestock use can be fenced with a 3-strand smooth wire fence, various types of post and rail fences, or moveable electric fence. Seasonal pastures, cross fences, and horse pastures lend themselves to designs that are much more permeable for wildlife.

3-Strand Smooth Wire Fence

Use 3 strands of smooth (barbless) wire. To increase visibility, use coated wire or barbless twisted cable – the latter can also be more durable than single strand smooth wire. (Note that high-tensile wire should only be used for electrified applications. High-tensile can also be difficult for animals to see, and horses can sometimes be cut by high-tensile wire.)



Christine Paige

3-Strand Smooth Wire Fence

- Top wire 40" to 42" high.
- Center wire 28" to 30" above the ground; maintain 12" spacing with the top wire.
- Bottom wire 18" above the ground.
- Preferably, no vertical stays.
- Wood or steel posts at 16.5-foot intervals.
- To increase visibility, use coated wire or double twisted smooth wire.

Christine Paige

Adjacent to bighorn sheep winter range, this smooth wire fence replaced old 4- and 5-strand barbed wire fence. The fence is 3-strand smooth wire with a 39" top wire and 16" bottom wire. Bighorn sheep now readily hop over and duck under the fences.

3-STRAND SMOOTH WIRE FENCE

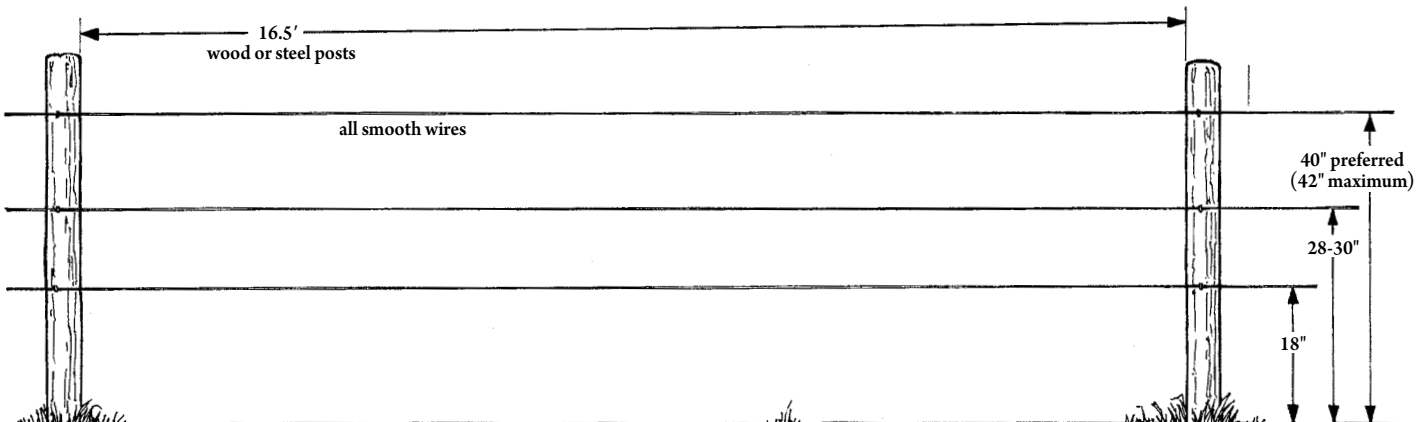



Seasonal Electric Wire Fence

A flexible electric fence that allows passage for elk and other ungulates can still be effective for livestock, particularly horses trained to electric fence. It can be laid down seasonally to allow free wildlife passage. This fence is useful for keeping livestock out of sensitive habitats or for short-duration grazing where permanent fencing isn't desired.

To work properly, this fence needs to flex as elk and other animals pass over it. Install as few rigid post supports as possible, and use the minimum recommended wire tension. Placing the energizer toward the middle of the fence will afford the greatest electrical efficiency.

Seasonal Electric Wire Fence

- Pre-drill 72" x 1" heavy fiberglass posts.
- Drive posts 24" into the ground at a 32-foot spacing (a t-post pounder can be used if ground is soft).
- Use treated wooden posts for bracing at ends and center.
- Place a top wire of conductive high-visibility tape, braided wire or polymer-covered wire no higher than 42" height, electrically charged (medium-tensile 12-gauge plastic-coated wire is satisfactory).
- Place a second grounded strand of high-tensile wire at 30".
- Attach strands to fiberglass posts with wire clips that can be removed when fence is laid down.
- Use insulators for attaching hot top wire to wooden posts; grounded wire can be stapled or clipped directly to wooden posts.
- Use a solar electric energizer (size and placement depends on the run length of fence).
- Hard-wiring is an option when a power source is readily available.



Jay Kolbe

This 2-strand seasonal power fence can be used where livestock are trained to electric fence. Wooden posts brace the ends. The fiberglass posts can be laid down when the fence is not in use.



Jay Kolbe

Moveable Electric Wire Fence

Moveable electric fence can be used for short-duration grazing, to keep livestock out of sensitive areas such as wetlands, or for other situations where livestock need to be temporarily controlled. This fence works well for livestock that have been previously trained to electric fence.

The design can be tailored to your situation, but a simple fence can be constructed using high visibility tape or “turbo wire” and fiberglass posts or plastic-insulated steel posts. A moveable fence can use either a single hot wire (when there is sufficient moisture for an adequate ground) or two wires, the top one hot, the lower wire grounded. Moveable posts on the market include designs with hooked or pigtail tops for quickly stringing wire, and a tread-in base. These can be rapidly set up and moved as needed.

Moveable Electric Wire Fence

- Use 40" to 42" fiberglass or plastic-insulated steel posts, designed with hooks or loops for wire and tread-in spikes at the base.
- Place one to two strands of high-visibility tape or polymer-covered turbo wire. If two wires, the top should be hot, the lower wire grounded. Top wire should be no higher than 42"; lower wire no lower than 18".
- Use a solar electric energizer (size and placement depends on the run length of fence).

Tips on Electric Fences

Most electric fence problems are caused by poor grounding. Follow the manufacturer's specifications for grounding the energizer and fence for your fence type and conditions. The number of ground rods needed may vary; a maximum reading of 0.2kv on a volt meter in dry conditions indicates an adequate ground. Wooden and steel fence posts require insulators for attaching hot wires; ground wires can be stapled or clipped on directly. Fiberglass and plastic line posts do not need insulators, but do require special clips for attaching wires. Check the fence regularly to be sure it is charged.



Seth Wilson



Christine Paig

A temporary electric fence can be used to keep livestock out of sensitive areas and is easily negotiated by most wildlife.

FENCE SOLUTIONS PUT TO THE TEST

Electric Fence Helps Rancher Work Smarter

Near Spotted Horse, Wyoming, 40 miles north of Gillette, Lindsay Wood helps ranch owner Don Spellman run a cow/calf operation with about 300 cows. The range is sagebrush shrub-steppe – pronghorn and mule deer country – with about 400 acres cultivated for hay that is also grazed.

Wood and Spellman favor a system of intensive rotational grazing and use temporary electric fence and electric cross fences to make their operation easily manageable. The meadows are dryland alfalfa and grass. Wood uses both single strand (one hot wire) and double strand (hot and ground) fences, and learned they don't need any more than that to control their cows. The double strand fences are the standard used for NRCS EQIP electric fence projects, however Wood finds that a single strand fence is often adequate for their operation.

"The cattle are trained to the fences," she says. "Once trained to it, and if you keep feed in front of them, they don't test our fences. Sometimes calves get out but they go right back in."

Many of their fences are marked for sage-grouse, but Wood and Spellman encountered problems finding an effective marker to use on smooth wire. Vinyl markers slide down the smooth wire, and if clamped tight the markers break. Reflective tape attached to the wire will conduct power, and if pronghorn go through the 2-strand fence, the vinyl markers can catch and tangle the fence wires. (For marking solutions, see page 14.)



The oldest perimeter fences on the ranch, once a sheep operation, are 5- and 6-strand barbed wire, which they keep maintained. However Wood says they rebuild about a mile of perimeter fence each year, replacing it with 4-strand barbed wire.

As for the electric fences, wildlife readily cross them and Wood never sees pronghorn blocked by a fence or tangled in wires. "They're incredibly cost-effective," Wood says. "They're easier to install, the

posts are easier to drive, and I'm not muscling and pulling on barbed wire." If she encounters a problem, such as a drop or loss of power, it's just a matter of getting out the fence tester. "You have to use your brain to figure out where your problems are," she says. "You can work smarter, not harder."

Once cattle are trained to the fence, a single-strand electric fence is highly effective for the intensive rotational grazing system on the Spellman Ranch.

Photos: Lindsay Wood



Post and Rail Fence

A post and rail fence is highly visible to wildlife and can be constructed for situations with or without livestock. Rail fences can either use a top rail with wires below, or two to three rails total. A 2-rail fence is preferable to a 3-rail fence for wildlife.

Unless the fence is quite low, use rounded poles for the top rail, rather than a square or split-rail, to prevent too much snow build-up in winter, which can deter

Post and Rail Fence

- Use pressure-treated 6' to 8' posts, spaced 10' to 14' apart.
- Use pressure-treated poles for top rail, placed 40" (42" maximum) above the ground. A half-round rail will attach more snugly and require shorter bolts.
- Place smooth lower wires at 18" and 28" above the ground. Second wire should be at least 12" below top rail.
- OR place pressure-treated poles for lower rails, the bottom rail placed with at least 18" clearance from the ground.

elk and deer. Also, unless the fence is easily jumped and there is ample clearance underneath, boards or planks

are not recommended as these can create a visual barrier.

POST AND RAIL FENCE

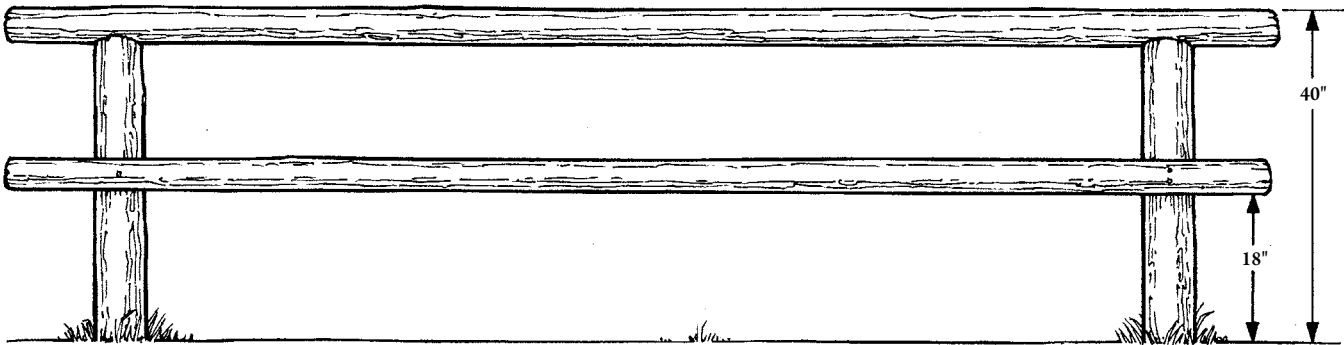

POST AND WIRE FENCE

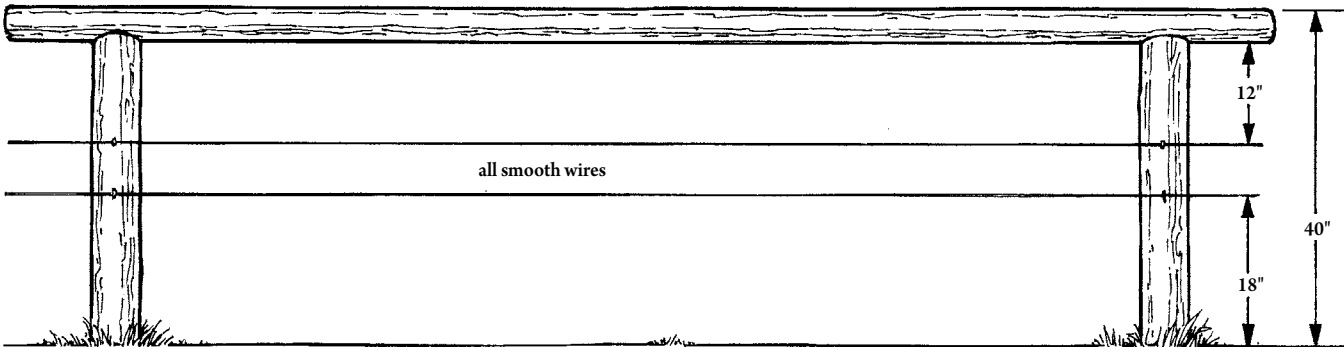

POST AND RAIL WITH 3 SMOOTH WIRES

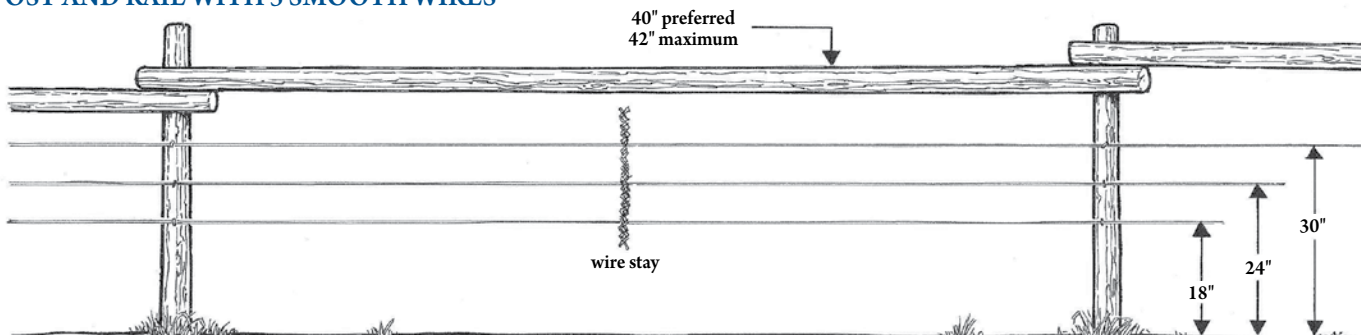



Christine Paige

Horse Pastures

A wide variety of fences can be used to contain horses, including post and rail, pipe, smooth wire, vinyl or electric poly-rope fence. Consider safety when choosing a fence. Horses have difficulty seeing wire fences, and if spooked can tangle in wires or suffer injuries on barbs and smooth high-tensile wire. Post and rail, pipe, vinyl and electric poly-rope fences are much more visible to both horses and wildlife, and reduce the risk of injury. Wood fences should be constructed with bolts, and treated rails and posts, as horses can break worn boards and weak rails, and nails can be a hazard as a fence wears.

If electric fence is an option, a 2-strand electric braided poly-rope fence is highly visible and allows animals to bounce off of the fence without injury to themselves or the fence. Nearly any standard fence can also be electrified with a single wire to prevent horses from



Christine Paige

touching or leaning over the fence—use electric braid or tape for visibility. Temporary pastures can be enclosed with a single strand of electric tape or braid.

The usual wildlife friendly standards apply: keep the top of the fence no higher than 42", which is adequate to contain nearly all horse breeds in most pasture situations (jumpers may be the

Rail fences are safer for both horses and wildlife—a top rail combined with smooth wire will contain most horses. Adding a wire stay will keep wires in place.

exception). Allow 12" between the top rail or wire and second rail or wire, and allow a clearance of at least 16" from the ground to the bottom rail, wire, or pipe for wildlife to scoot underneath.



Christine Paige

A Better Buck and Rail Fence

Traditional buck and rail fence creates a formidable hazard to wildlife. It is usually built too high, too wide, and with rails placed too closely together for animals to cross easily. The 3-D design is especially hard to leap over or crawl through, and

Most traditional buck and rail fences are too high, too wide, and have too many rails for wildlife to negotiate.

animals can tumble and break legs. When combined with woven or barbed wire, or placed on steep terrain, it creates a complete barrier.

Buck and rail is also expensive and requires high maintenance as the rails rot and collapse under snow loads.

However, for some this fence style evokes tradition and history, and it is practical in rocky or wet ground where posts can't be driven. With some modifications, buck and rail can be built for much easier wildlife passage.

Buck and Rail Modified for Wildlife

- Do not place a rail in the “cradle” of the bucks.
- Install two rails on the outside, top rail at 40" and bottom rail with 18" clearance from the ground.
- Do not install an interior rub rail. Instead, in alternate sections, install crossed rails on the interior to stabilize the fence.
- The alternating 2-rail sections allow animals to cross more easily.
- Add a brace at the bottom of the buck to “close the triangle” and stabilize the bucks.
- Never add woven wire or barbed wire to the fence.

BUCK AND RAIL MODIFIED FOR WILDLIFE

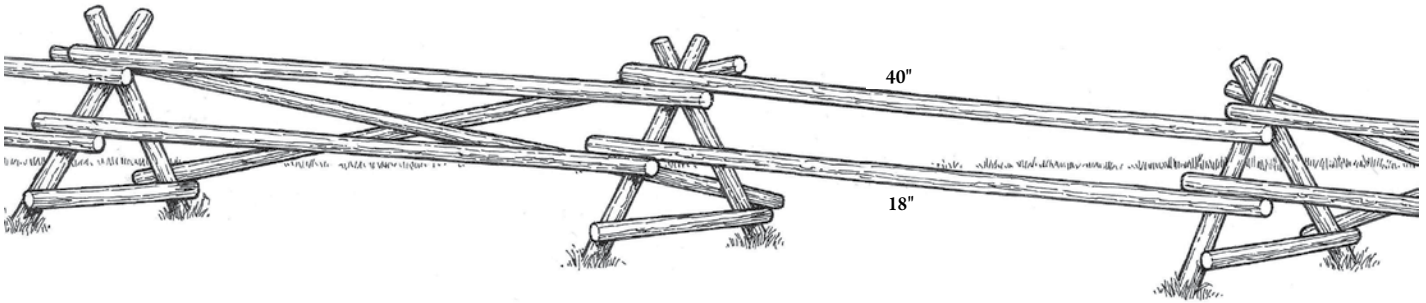

Worm Fence

Worm fence, also called zigzag fence, was used by early settlers because it's easy to construct and can be used on rocky, uneven ground and where posts can't be driven. The zigzag gives the fence its stability. Worm fence is still popular in some places for its rustic style, but is not used to contain livestock.

Although larger animals can jump low worm fence more easily than 3-dimensional buck and rail or conventional barbed wire, it is still a barrier to young and

mid-sized animals. Other drawbacks include rotting, the large number of rails needed, the space it takes up on the ground, and maintenance.

To make worm fence friendlier for wildlife, stack 3 to 4 rails per section no higher than 36", interlaced at the ends at a 30-degree angle. Stack the ends of the bottom rails on flat rocks or short logs to postpone decay. For extra stability, fasten rails with 6" nails or spikes, or drive 4' lengths of rebar into the ground on either side of the joint, flush with the top rail.



Christine Paige

A low worm fence can be hopped by most ungulates. Drop the top rail to the ground at intervals to allow young and small animals to cross.

Create openings for wildlife by dropping or eliminating the top rail at regular intervals, and at likely crossing points.



Sites with High or Continuous Livestock Use

Most livestock pastures do not require a 5- to 6-strand barbed wire fence. In many situations, a 3- or 4-strand barbed wire fence, a combination of smooth and barbed wire, or a high-tensile electric fence will work well for livestock control, particularly if the pasture quality inside the fence is as good or better as outside the fence.

Tips for Livestock Fences

Sheep, bison and cows with calves may require a more impermeable fence for control. If you must use fences with woven wire or more than four wires follow these tips:

- Consider the placement of the fence perimeter carefully, and limit the extent of impermeable fence wherever possible.
- Avoid excluding wildlife from streamsides and water sources, or cutting off migration and travel corridors.
- Keep the fence height to a maximum of 40" to 42" and create periodic crawl-openings for fawns and calves by raising the bottom 18" from the ground, placed where animals typically travel.
- Avoid topping woven wire fences with barbed wire. In any situation, allow 12" between the top wire and the next wire below – whether barbed or woven wire.
- Create seasonal openings using lay-down fence sections or gates to open the fence during months when livestock are not present.



Christine Paige



Christine Paige

Create seasonal openings by leaving a gate open, lowering rails or wires, or using sections of lay-down fence during months when livestock are not present.

4-Strand Barbed Wire for Cattle or Sheep

Woven wire fence, the most commonly-used type of fence on sheep range, is also the most problematic for wildlife. It can block wildlife passage, particularly for fawns, calves, pronghorn and medium-sized animals unable to jump fences. When combined with barbed wire, it has the highest rate of entanglements for wildlife.

An alternative for sheep and cattle range is a 4-strand barbed wire fence that controls livestock but still allows for passage of pronghorn, deer, moose and elk.

For cattle, use a wire spacing of 18–22–28–40/42". The top wire should be at 40" to 42" or less. Allow 12" between the top two wires and 18" between the bottom wire and the ground. Use a smooth bottom wire.

Sheep require a low fence that would block most wildlife from crawling beneath the fence, however a 4-strand fence for sheep can have a top wire no more than 32" high, which is low enough for most wildlife to jump. Allow at least 10" between the top two wires. (As a lower fence is easier for deer and elk to jump, the 10" spacing between top and second wires will usually be adequate.) The bottom wire should be smooth wire and at least 10" above the ground.



A bottom smooth wire aids passage for pronghorn and other wildlife.

Combination Smooth and Barbed Wire Fence

In many situations, a combination of smooth wire and barbed wire can effectively contain livestock and allow for easier wildlife passage. Smooth wire can be used for the top and bottom wires and one to two barbed wire strands are used for the center strands. Barbless twisted cable wire or coated wire will increase visibility for wildlife. The top wire should be 40" to 42" high or lower, and the bottom wire at least 18" above the ground to provide wildlife clearance. Allow at least 12" between the top and second wires.

Combination Smooth and Barbed Wire

- Place top smooth wire at 40" to 42" maximum height – barbless twisted cable wire or coated wire is recommended.
- Allow at least 12" between top and second wires.
- Place bottom smooth wire at least 18" from the ground.
- Use barbed wire for center two wires.

Sheep and Cattle 4-Strand Barbed Wire Fence

(Adapted from Wyoming Game and Fish Dept., 2004)

Recommended Wire Heights Above the Ground

	Cattle	Sheep	Sheep & Cattle
Top wire	40" to 42" barbed	32" barbed	38" barbed
2nd wire	28" barbed	22" barbed	26" barbed
3rd wire	22" barbed	16" barbed	18" barbed
4th wire	16" to 18" smooth	10" min. smooth	10" min. smooth

4-STRAND BARBED WIRE WITH BOTTOM SMOOTH WIRE

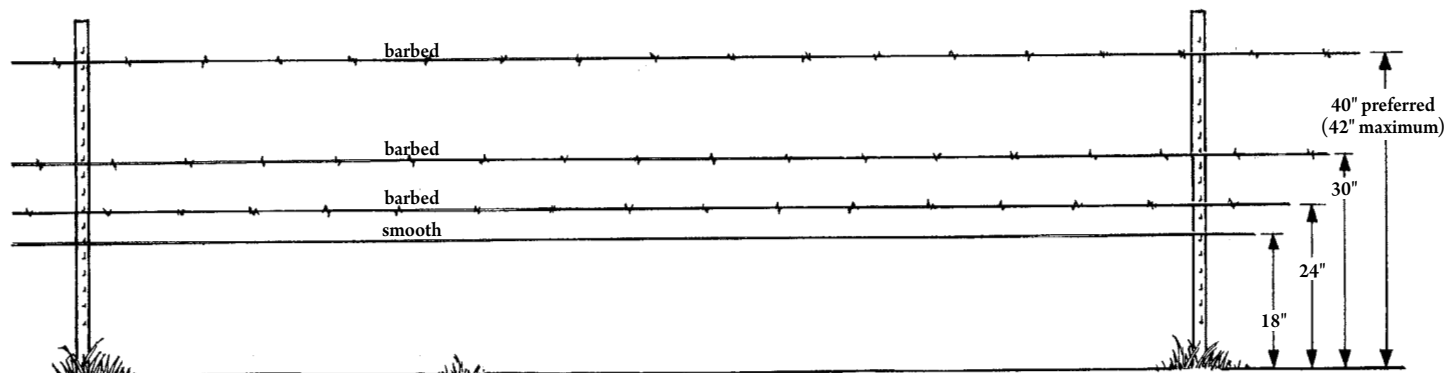

FENCE SOLUTIONS PUT TO THE TEST

High-tensile Fence a Practical Solution on the Pokorny Ranch

Steve Pokorny and his family were dealing with miles of old fence on their ranch in Fremont County, Wyoming, where they run a cow-calf operation. “The newest part of the fence was built in the 1950s, and it had been mended up for 60 years,” explains Pokorny. Over the years, wires were patched and added, so the fence was a maintenance headache and a hazard for the abundant wildlife in the area.

“When you have irrigated ground you get a lot of deer and antelope, and they can raise havoc with a customary barb wire fence,” says Pokorny. The ranch is also in the middle of a high density area for sage-grouse in Wyoming. Sage-grouse leks border the valley on surrounding uplands, and in summer grouse use the ranch’s hay meadows.

In 2011, through a cost-share project with NRCS, Pokorny replaced 10 miles of old barbed wire boundary fences with 3-strand high-tensile wire fence (top wire hot, middle wire ground, and bottom wire hot).

The cattle took no time at all to train to the power fence. “All it takes is one time for one of them and then they all seem to know,” Pokorny says. “The antelope, with their hollow hairs, go right under it and the deer jump right over it.”

Pokorny went into the project with some confidence in high-tensile fence, having used it to divide an allotment several years ago, and he doesn’t expect problems. Now deer and pronghorn can move freely through the ranch and adjacent lands without tangling in or breaking down the fences. The new fence reduces maintenance, which not only helps the family’s operations today, but was a consideration for the next generation coming up on the ranch as well.

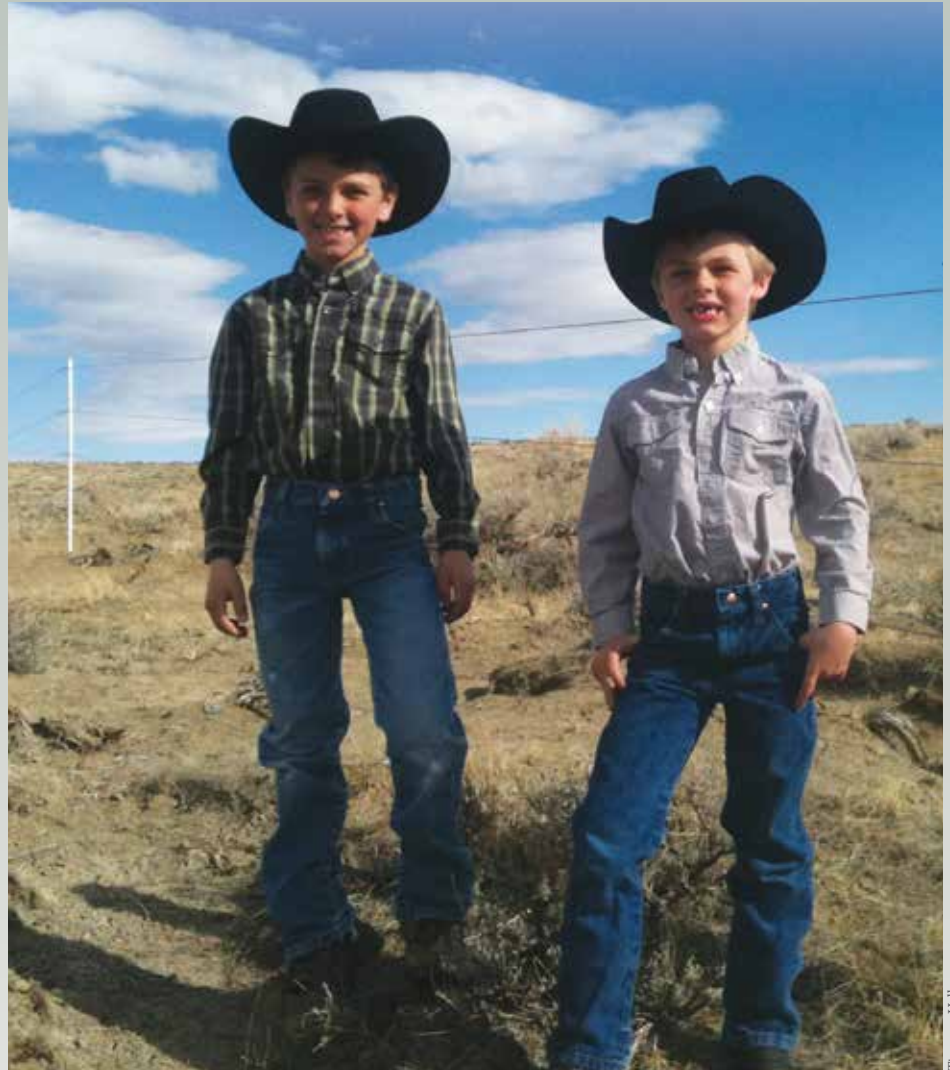

Timmy Hellyer

Maclean Hellyer and Joseph Hellyer, grandsons of Steve Pokorny, show off the new high-tensile fence on their family ranch. Thinking of the next generation coming up on the ranch, durability and ease of maintenance was a primary concern when Steve Pokorny replaced 10 miles of old boundary fence.



Rory Karhu

3-Wire High-tensile Electric Fence

Researchers in Wyoming found that a flexible 3-wire high-tensile fence (with a hot – ground – hot configuration) is not only effective for containing cattle and bison, but allows elk, mule deer and pronghorn to traverse the fence. They found that wild ungulates usually were not deterred by electric fences even with charges ranging from 0.5 and 4.5 joules, perhaps because of the insulating properties of their hair. Although wild ungulates were occasionally shocked when they nosed or bit a wire, or touched hot and grounded wires together, most animals readily negotiated the fences.

Further, the researchers determined that 3-wire fences effectively contained bulls separated from cows coming into estrus, and calves from cows in the fall. Also, they found that a 3-wire fence was just as effective for containing bison as a 4-wire fence. A 2-wire fence can be used for areas without weaning calves but, curiously, pronghorn showed a high aversion to 2-wire fences, perhaps because of the novel height and their general reluctance to jump fences rather than crawl under (Karhu and Anderson 2003, 2006).

High-tensile fences require proper construction techniques, including



Rory Karhu

adequate braces, proper tensioning, care not to kink or break wire, and proper attachments and insulators for line posts and braces. The flexibility of the fence is key to allowing wildlife to pass over and through the fence. Fiberglass posts are used for all line posts, and wooden posts are used only for braces, direction changes and gates.

High-tensile fences need minimal maintenance, provide great strength, can be easily electrified and will outlast most other fences. For technical details, see the Natural Resources Conservation Service (NRCS) specifications for permanent power fence (NRCS 2006a).

A 3-wire high-tensile electric fence is effective even for separating bulls from cows in estrus, and for containing bison. Using high tensile wire at the proper tension is key to prevent wildlife damage.

Note that smooth high-tensile wire can be difficult for animals to see. Adding markers or survey flagging to the top wire can help. One commercial example that works on smooth wire is the See-A-Fence flags, available at www.knifedgellc.com/seeafence.html.

Keeping the fence powered prevents wildlife from leaning into it. If power is off, consider laying the fence flat to the ground if it will not create an entanglement hazard.

3-WIRE HIGH-TENSILE ELECTRIC FENCE

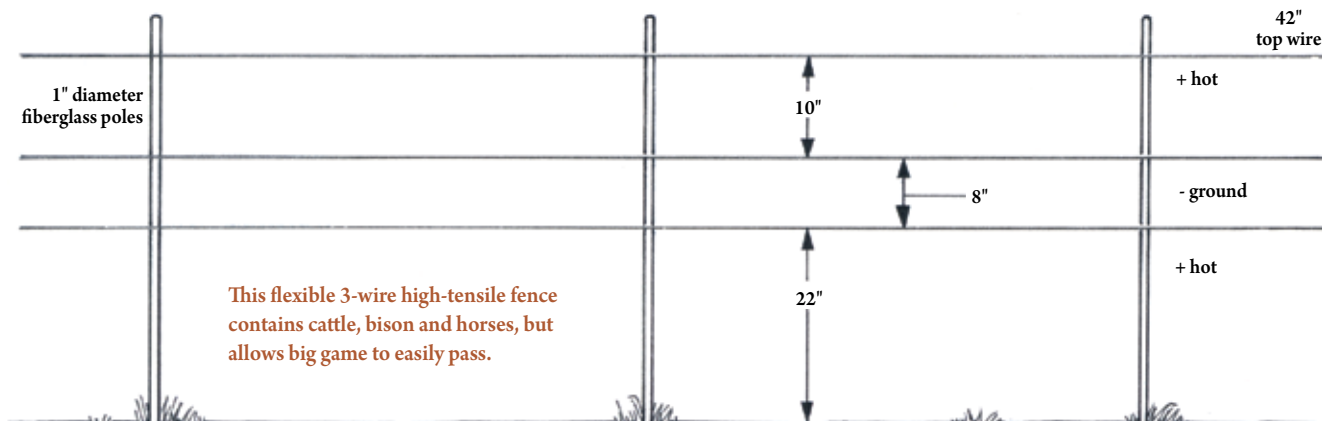



Rory Karhu

3-Wire High-tensile Electric Fence

Maintaining fence flexibility is key to allowing wildlife to traverse the fence.

- Use fiberglass line posts no greater than 1" in diameter.
- Brace fence with wood posts at least 5" in diameter; brace all corners, gates, and direction changes greater than 15 degrees. Appropriate insulators are needed with wooden posts.
- Space line posts 45' to 60' apart and do not use stays. Fence stays make it harder for wildlife to pass between the wires, and may cause the fence to flip.
- Smooth, 12.5 gauge, Class III galvanized wire with a tensile strength of 170,000 PSI and breaking strength of 1308 lbs. is adequate.
- Increase visibility by using flagging, fence markers or high tensile wire coated for visibility.
- Top wire is hot; second wire is grounded, bottom wire is hot.
- Space wires at 22–30–40/42" from the ground. The top wire should be no higher than 42" with 10" between the top two wires. The 10" spacing is necessary for cattle to contact both hot and ground wires, but poses little hazard for wildlife due to the fence's flexibility. A bottom wire at 22" allows both young and adult wild animals to pass under easily.
- Connect wires to posts with metal clips or fasteners designed for electric fences; use porcelain insulators on wooden braces.
- Tighten wires to 150 lbs. tension. If too tight, the wires are more likely to break. Although high-tensile wire has a high breaking point, it is also more brittle, and easily broken if tightly bent or kinked.
- Place solar energizer according to manufacturer recommendations.
- Ground fence properly according to the energizer instructions, and add extra rods as needed. Locate ground rods at fence ends and intermittently in between.
- Ground rods are relatively cheap and extra rods will ensure the fence will be effective.
- When livestock aren't present, either drop the wires flat to the ground or keep the fence electrified to prevent wildlife damage. (Keeping the fence powered can also prevent the battery from freezing and prolong battery life.)
- Securely attach electric fence warning signs intermittently along the fence and at crossing points.

FENCE SOLUTIONS PUT TO THE TEST

Experience Nets Advice on Wildlife Friendly Fence

Plenty of elk and pronghorn migrate across John Nunn's ranch in Albany County, Wyoming. His operation, Needmore Land & Cattle, runs mother cows, calves and yearlings, depending on the market, and covers a checkerboard of BLM and state lands in addition to private ranch land. Once a sheep operation, the ranch had extensive woven wire and traditional 5- and 6-strand barbed wire fences, which slowed game movement through the area.

Nunn partnered with NRCS on a cost-share project and installed more than 4 miles of wildlife friendly fence: a 4-strand fence with three barbed strands and the bottom wire smooth. The top strand is at 42" or less, with 12" spacing between the top and second wires, and the bottom smooth wire is at 16" to 18".

After two to three years' experience with the fence, Nunn's experience has been largely positive. "The fence works well, especially on open plains," he says. Although in 30 years Nunn only had one instance of an antelope tangled in his old fence, he still likes the new 4-strand fence as it allows for freer wildlife movement. "Wildlife can flow through a lot easier now."

In some situations, livestock will test a fence when motivated by something more attractive on the other side. A watering hole, tank or water gap can be strong motivation, as can heifers and bulls on either side of the fence. Nunn says his yearlings sometimes test the fence if there is something tempting outside it. "They're just teenagers. They're curious and just create more problems."

The 16" to 18" bottom wire allows antelope to pass under easily, and isn't usually an issue for calves that slip through

as they will crawl right back to their moms. However, Nunn suggests it could pose a problem if the fence divides two groups of cattle, both with mothers and calves.

In short, when planning your fence Nunn advises thinking about your specific operation, as well as that of neighbors with adjoining pastures, and using a combination of wildlife friendly and traditional fence if needed.

As for wildlife, he says, "The fence works great."



Jeremy Roberts, Conservation Media

On the Needmore Land & Cattle operation in Albany County, a 4-wire wildlife friendly fence works well across open plains.

Photo: Ruben Vasquez, NRCS





Openings, Crossings and Passes

Fence passes reduce injuries, keep fawns and calves from being stranded, provide openings for animals unable to jump fences, and help wildlife cross in deep snow.

You can include wildlife crossings in any fence design. Short sections can be altered to wildlife friendly standards to help wildlife cross, or gates and jumps can be added. The simplest solution is to install gates that can be secured open when pasture isn't used by livestock.

Animals are creatures of habit—place jumps and openings where there are signs of habitual crossing by wildlife.



Christine Paige

Look for worn trails, tracks, and hair caught on fence wires. Also place crossings in fence corners and sites where animals are funneled by topography or the fence line.

Fence openings and passes are especially important when fawns and

An easy solution is to secure gates open in seasons when livestock aren't present.

calves are small, from June 1 through the summer, and for seasonal wildlife movements and ranges. They can reduce fence damage and decrease maintenance costs.



Christine Paige



Christine Paige



Christine Paige

Fence alterations can include:

- Lowering the top wire or rail to 42" or less.
- Increasing the distance between top and second wires to 12".
- Raising the bottom wire or rail to 16" minimum, and preferably 18" or more.
- Replacing the bottom and top wires with smooth wire.
- Increasing visibility with a top rail, pvc pipe, high-visibility tape or braid.

Wildlife openings and passes can include:

- Gates secured open.
- Dropped rails and wildlife jumps.
- Sections with adjustable wires or rails.
- Sections of seasonal lay-down fence.
- PVC modifications for big game and pronghorn passage.

Use your local topography and patterns of wildlife travel to help you determine the best placement for crossings. Look for signs of wildlife use and travel such as game trails, tufts of hair caught on fence wires, trails to water, or gullies and swales that act as wildlife corridors.

Durable PVC Big Game Passage

Installing PVC pipe over bunched fence wires is an inexpensive way to allow elk, deer, and antelope to freely cross existing barbed wire fence with minimal risk. This design is especially useful where elk, moose or other ungulates cross heavily traveled roadways and have difficulty crossing a fence, delaying their movement out of danger – particularly in spring and summer when calves are small. Along roads, the PVC passage should be installed on both sides of the right-of-way.

PVC pipe threaded over bunched fence wires creates an effective and durable big game passage, especially on road right-of-ways.



Montana Fish, Wildlife & Parks



Montana Fish, Wildlife & Parks





PVC Game Passage for Wire Fence

These instructions are for a metal t-post, 5-strand barbed wire fence, with no livestock present, but can be adapted for other situations.

Materials:

To modify two 60' sections of barbed wire fence.

- Twenty 10' sections of 1.5" OD PVC pipe
- One 100-count bag of large (7" or 11") UV-resistant plastic cable ties
- #16 or larger soft wire
- fencing pliers, wire cutter, leather gloves

Before Installation:

With a table saw, cut a 1/4" slot the entire length of each PVC pipe. Note that a 1/4" cut can be made by matching up two 1/8" wide blades and using a wood guide.

Installation:

Step 1: Remove all wire clips from about 60' or three fence posts and allow wire to hang freely.

Step 2: Beginning near first post with clips removed, grip the top three strands of wire and pinch together. Locate a space between barbs that will allow you to thread on the PVC pipe. Push pipe onto wire (not wire into pipe) concentrating on fore-end of pipe. If the pipe gets hung up on a barb at the fore-end, work barb into end of pipe and continue. Once the pipe has been adequately started, grip pipe near the fore-end and begin pulling down the length of the wire. The wire will feed itself into the pipe. Pull pipe down the wire until about 8' from where posts with clipped wires resume.

Step 3: Repeat with three more pipes. Space the joint between two pipes at a post where possible. This will allow you to clip the three wires together to a post.

Step 4: The last (fifth) pipe must be installed in the reverse direction. Starting near the end of the fourth pipe, find a space between barbs and install pipe as in Step 2, push into place 8' from where posts with clips resume.

Step 5: Repeat steps 2 through 4 with the bottom two wires.

Step 6: Using #16 or larger soft wire, attach the top PVC pipe to posts no more than 40" above the ground. Attach the bottom pipe at 18" above the ground, or dropped closer the ground to create a larger middle gap for deer fawns/elk calves to go through rather than under. Where a joint between pipes is located at a post, enough space can be left to clip the wires to the post.

Step 7: Attach three cable ties per 10' section of PVC pipe, one near each end and one in the middle. Squeeze PVC pipe while pulling cable tie tight. Gap from cut will not be completely closed but will be small enough to allow the pipe to roll and not work its way off the wire. Clip tag end of cable tie.

Step 8: Repeat on opposite side of right-of-way.



An elk herd races to cross a highway. Animals are especially vulnerable to tangling when alarmed or crowded by others.

Shawn Bryant





Adjustable Wire Fence

Adjusting the height of one or more wires is an easy and effective way to allow animals to cross during migration periods if livestock aren't present. Drop the top wire to the level of the second wire, either in sections or along an entire run of fence, to allow wildlife to jump over easily. Lowering the top wire to 25" or less allows elk and deer to hop over easily in almost all conditions. Raise the lowest wire in the same way to help wildlife crawl under. A simple staple lock allows wires to be rapidly adjusted from one level to another and the wires can be adjusted by only one person.

Fence clips or staple locks allow wire heights to be quickly adjusted to create seasonal crossings for wildlife. Fence clips are available commercially for steel or wood posts from Tin Cup Creek Fence, tincupcreekfence.com.



tincupcreekfence.com

steel post fence clip



tincupcreekfence.com

wood post fence clip



Ranch manager Marina Smith found that a seasonal drop-down top wire allows migrating elk to easily pass over the fence in fall and winter.

Christine Paige



ADJUSTABLE FENCE FOR SEASONAL WILDLIFE PASSAGE

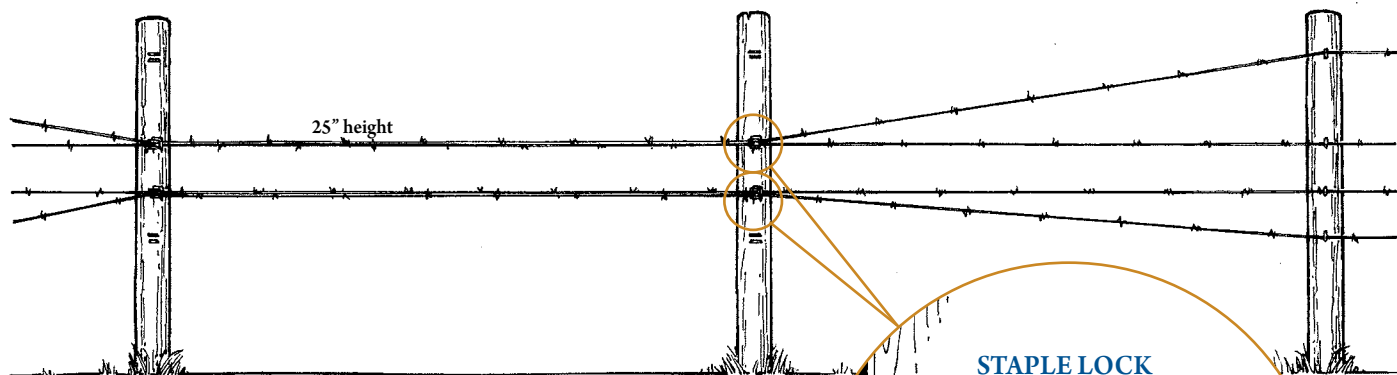

Staple lock for wooden posts

- Install two fence staples horizontally and less than an inch apart on each post at the level of both the top wire and the second wire.
- Slip the fence wire between the two staples.
- Secure it in place by hooking a third staple through the paired staples vertically, like a latch.



Marina Smith

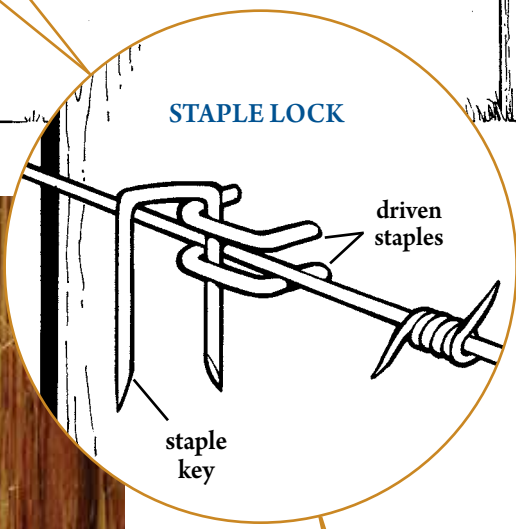

4-WIRE FENCE (SMOOTH AND BARBED WITH STAPLE LOCKS)

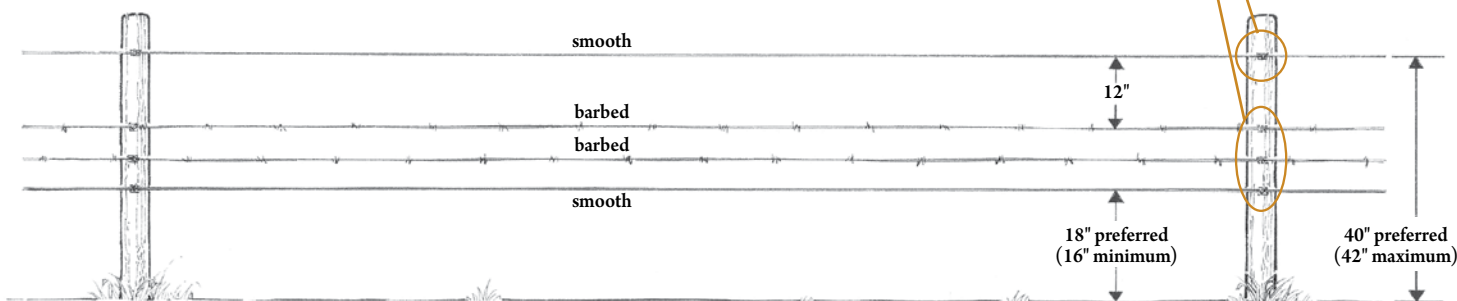

Pronghorn Underpass or "Goat Bar"

Although capable of jumping even high fences in extreme situations, pronghorn prefer to crawl under fences, and almost seem unaware of their ability to "high jump." They will often run for miles looking for fence openings or spots to crawl under a fence, and have been known to die of starvation when blocked by a fence they see as impassable.

In Sheep Range:

Pronghorn have the greatest difficulty negotiating sheep fence, which either uses lower barbed wire strands than cattle and horse fence, or is typically made of woven wire. However, a pronghorn "underpass" can be created by raising the bottom strand in selected fence sections.

- For sheep, space wire strands at 10–16–22–32" above the ground, the top three strands barbed wire, the bottom strand smooth wire.
- In selected sites, raise the bottom wire to the height of the third wire, securing in place with a staple lock on the posts, or with small carabiners or quick-clips on the wires. If needed, the bottom wire can be dropped again when sheep are present.

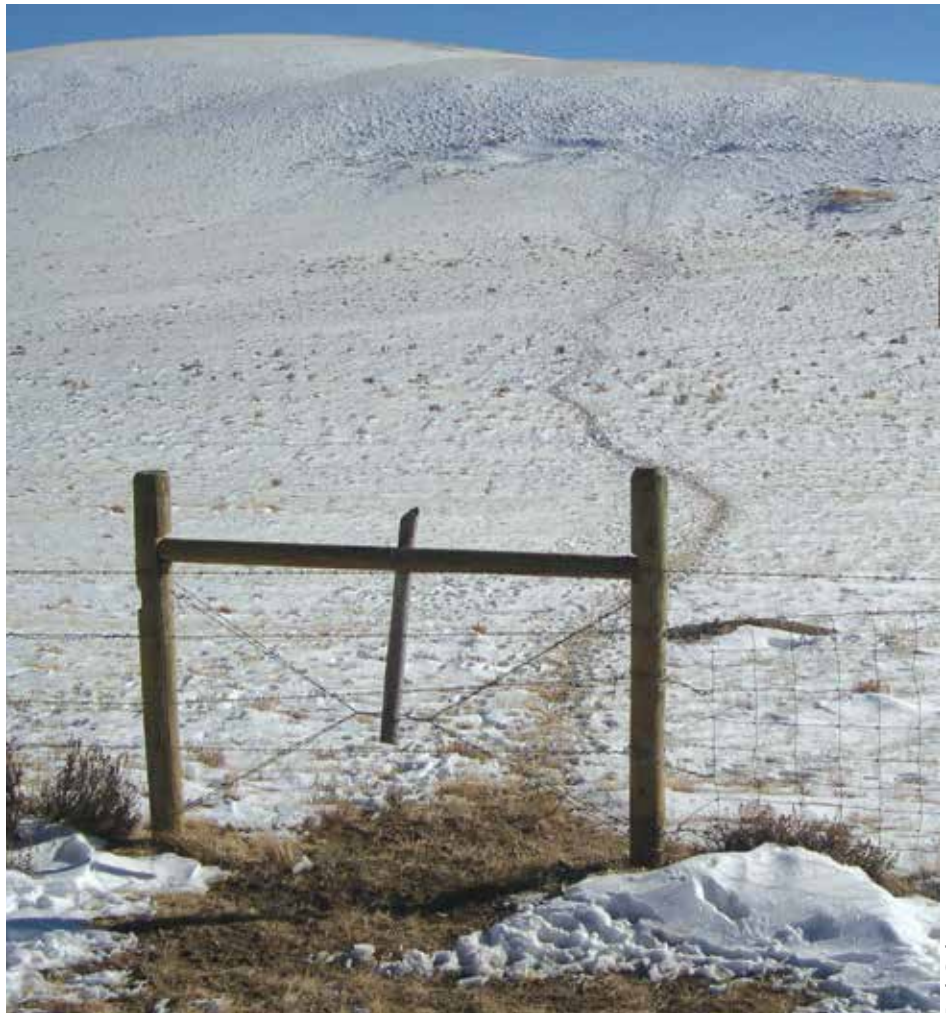

Randy Gazda

Pronghorn tend to use the same trails and fence crossings habitually. You can make negotiating fences easier by raising the bottom wire at known crossing sites.

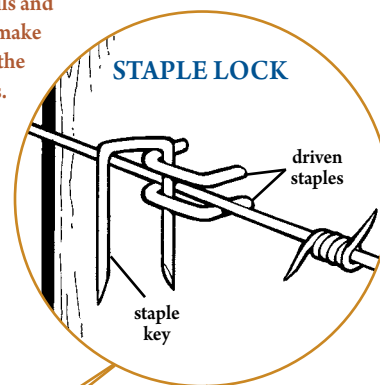

PRONGHORN UNDERPASS FENCE WITH RAISED WIRE

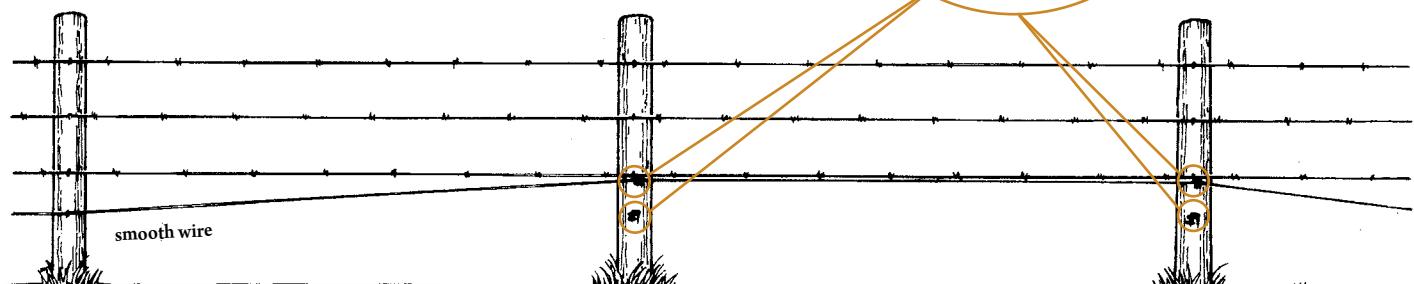



PRONGHORN UNDERPASS FENCE WITH GOAT BAR

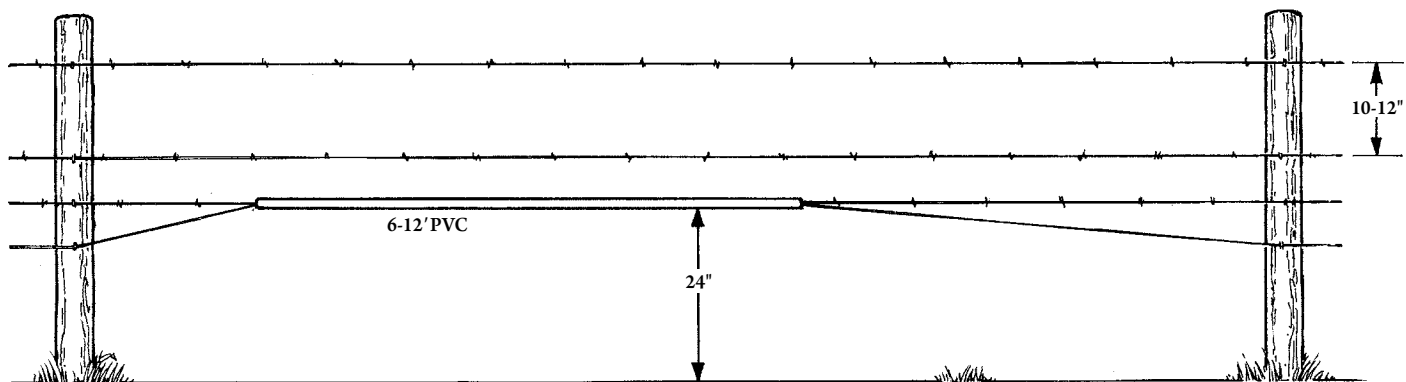

In Cattle and Horse Range:

A pronghorn underpass or “goat bar” can be created by simply gathering the bottom two wires in a PVC pipe to make a higher clearing for pronghorn of any age to crawl under. The PVC also protects animals from losing hair on barbed wire, and the fence remains effective for controlling horses and cattle. An alternative is to use quick-clips or small carabineers to clip the bottom wire to the next highest wire. **To be most effective, place the underpass where pronghorn habitually cross.**

- Space fence wires heights at 18–24–30–40”; use smooth wire on the bottom.
- Cut several 6’ to 12’ lengths of PVC pipe.
- With a table saw, cut a ¼” slot the length of each PVC pipe. Note that a ¼” cut can be made by matching up two ⅛” wide blades and using a wood guide.
- Grip the bottom two fence wires together, and feed the PVC pipe onto the wire from one end of the pipe.

Once the pipe has been adequately started, grip the pipe near the fore-end and begin pulling down the length of the wire.

- Place the underpasses where pronghorn habitually cross (look for trails and hair on wires) and in fence corners where animals may be directed by the run of fence.
- Add a PVC pipe threaded onto the top wire or top two wires to allow easier passage for deer and elk and reduce the chance of snagging and entanglement.
- Use 2 or 3 cable zip-ties to close up the gap on the PVC.



Barbed wire can cause serious scarring and hair loss on animals’ backs and bellies (above). While a PVC goat bar can protect from scarring, simply raising the bottom wire with quick-clips (at right) can also ease passage. Underpasses are most effective when placed where animals habitually cross.



Lay-down Fence

A lay-down fence is a standard 3-wire or 4-wire fence that can be laid on the ground as a unit to allow ungulates to pass through during migration or seasonal use. A lay-down fence can reduce wildlife damage and save maintenance costs. Most designs allow a single person working alone to easily let the fence down or put it back up in a short time.

Lay-down fence can be constructed from smooth wire or barbed wire. Fence posts can be wood or steel, but treated wood is more durable in heavy snow areas. To be most effective for elk and

reduce fence damage, install lay-down in at least 4 to 6 sections of fence. In areas with heavy elk migration or winter use, entire fence runs can be installed with lay-down fence to minimize wildlife fence damage.

Space posts at 16.5' intervals. For barbed- or smooth-wire fence, one to two stays are needed between fence posts, plus a stay lined up with each fence post. Wire loops, secured at the top and bottom of the fence posts, support the fence stays. Be sure the fence stays do not touch the ground. The lay-down section can then be dropped by flipping up the top loop and lifting the stays out of the bottom loop.

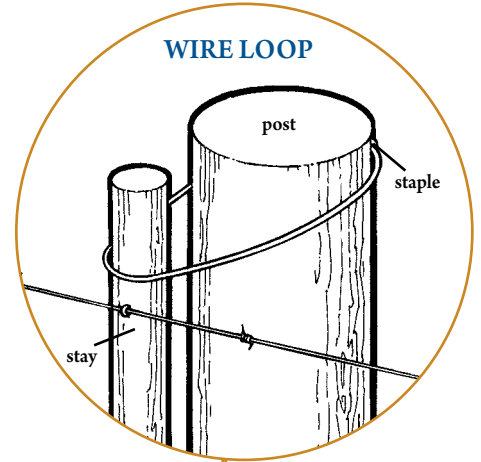

LAY-DOWN FENCE

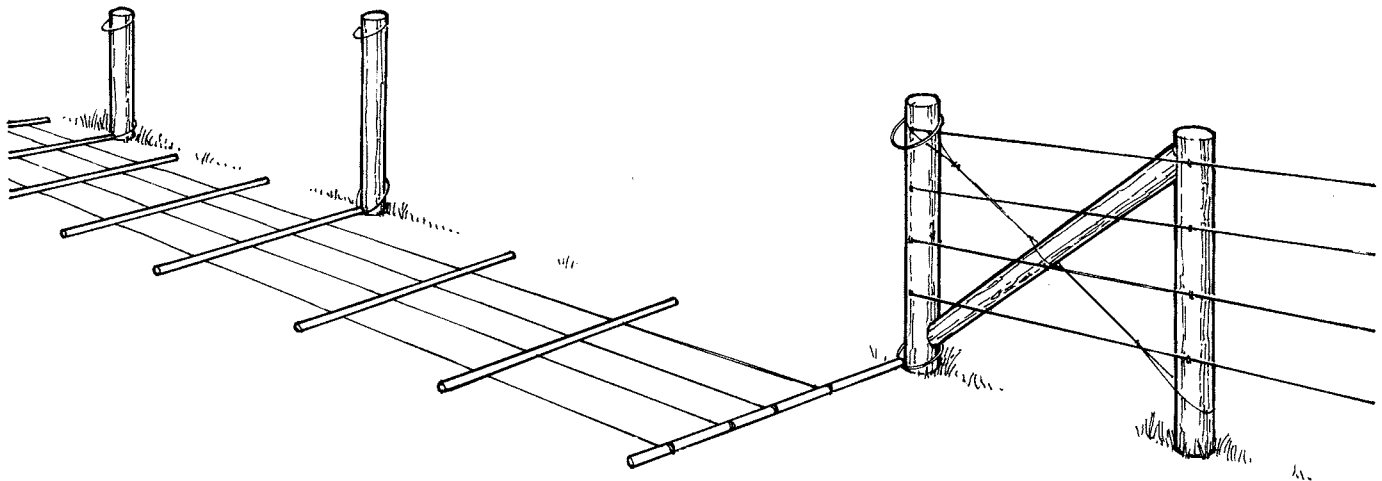
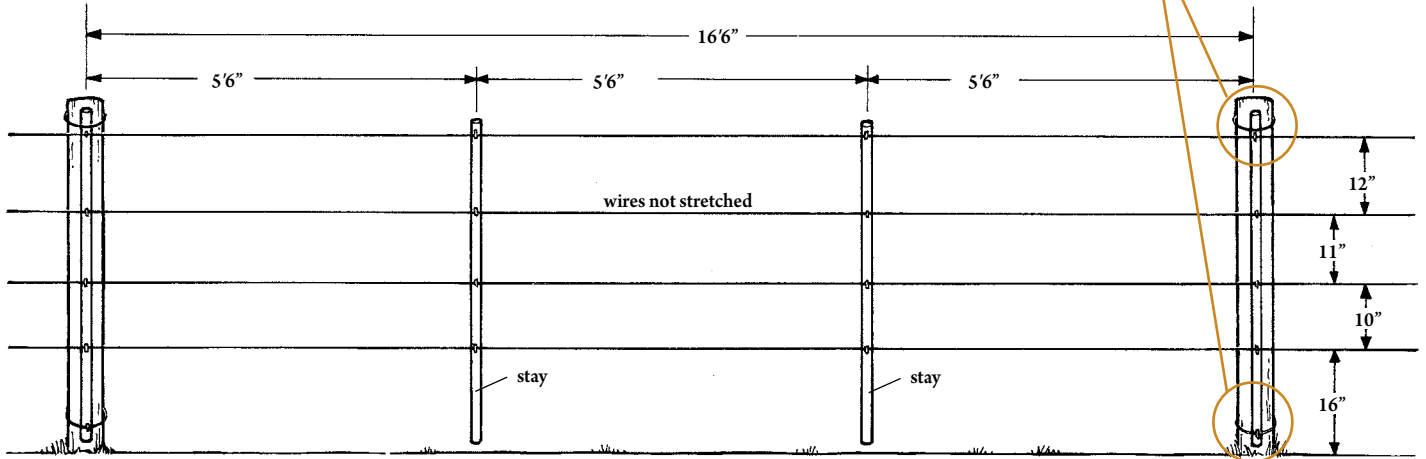



Montana Fish, Wildlife & Parks



Jay Kolbe

This lay-down fence using 4-strand smooth wire was constructed along 1.5 miles of fenceline next to the Blackfoot-Clearwater Wildlife Management Area in Montana to allow winter passage for elk. The number of elk tracks attest to the design's success.



Christine Paige

FENCE SOLUTIONS PUT TO THE TEST

Sublette County Aids Migrating Pronghorn

Where the Green River and its tributaries flow across the high sagebrush rangelands of Sublette County, a river of big game also streams through—elk, mule deer, pronghorn and moose migrate to winter range where the wind scours snow away from winter forage, and then return again to the high country as snows recede in spring. The Green River Basin is also ranch country, with 250 working ranches, more than 100 of which have been owned and operated by the same families for over a century.

In 2008, the local Green River Valley Land Trust (GRVLT, formerly Wyoming Land Trust) launched the Corridor Conservation Campaign, a multi-year effort to help ranchers modify

existing fences to be friendly to wildlife and effective for livestock. The campaign targeted fences in the “Path of the Pronghorn,” the longest large mammal migration in the lower 48 states. Each autumn, pronghorn that summer in the Jackson Hole area migrate out of the Gros Ventre River Basin across a high divide and into the Upper Green River Basin to winter. But pronghorn have difficulty negotiating fences: they would rather crawl under than jump over a fence, and may be blocked by fences they cannot easily cross.

GRVLT brought together ranchers and local land and wildlife management agencies to modify existing livestock fences to 3- or 4-strand fence, with the top wire at 42", and 12" between the top two strands to avoid tangling by mule deer, elk and

other animals jumping over. The bottom strand is smooth wire set at 16" minimum height to allow pronghorn to slip under the fence. Woven wire fence was replaced with 3- or 4-strand fence, and in moose habitat a wooden top rail was installed. Wherever possible, existing wire and posts were used as long as they were in good shape, but old wire and posts were replaced, providing landowners with a durable fence.

By the end of 2012, GRVLT and their partners completed 82 miles of fence modifications in the Path of the Pronghorn, and a total 166 miles in the county. Since then, the Wyoming Wildlife Foundation and other organizations have continued the fence work to ease the journey for migrating deer and pronghorn in the region.

In Sublette County, the local land trust helped landowners modify fence to ease migration of pronghorn, mule deer and other wildlife.

Photos: Green River Valley Land Trust.





Dropped Rail Wildlife Passage

Buck and rail fence, high post-and-rail fences, and worm fences can be difficult for animals to negotiate. An occasional gap in the fence can provide a crossing. Rails should be dropped where there are signs of wildlife movement, such as game trails, and in pasture corners, stream corridors, gullies or other natural funnels.

Simply drop one end, or the entire rail, of the top rail to the ground intermittently, such as

every 100', to allow animals to step across. Installing the top rail with anchor bolts and wingnuts makes it quick work to alter the rail seasonally where needed.



Christine Paige

DROPPED RAIL FOR WILDLIFE JUMP

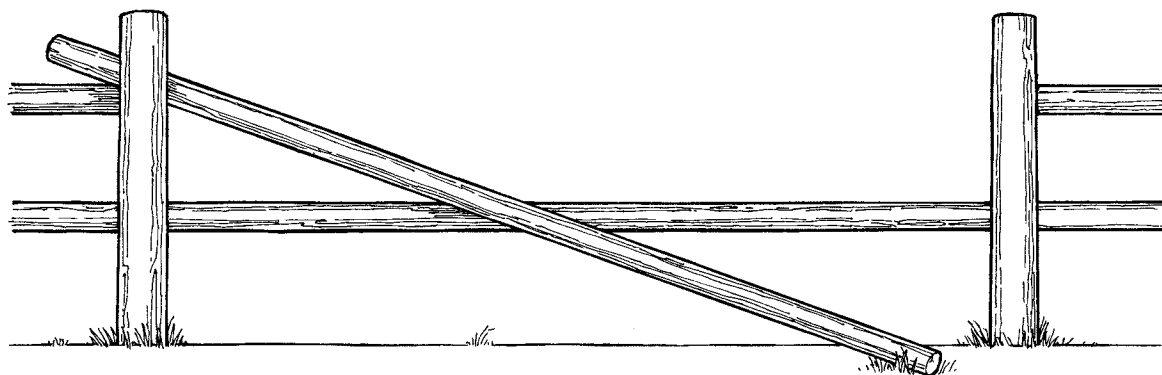

A top rail can be dropped on one end, or lowered to the ground entirely. Installing a top rail with anchor bolts and wingnuts makes it easy to alter the rail seasonally.



Christine Paige

DROPPED RAIL IN BUCK AND RAIL FENCE

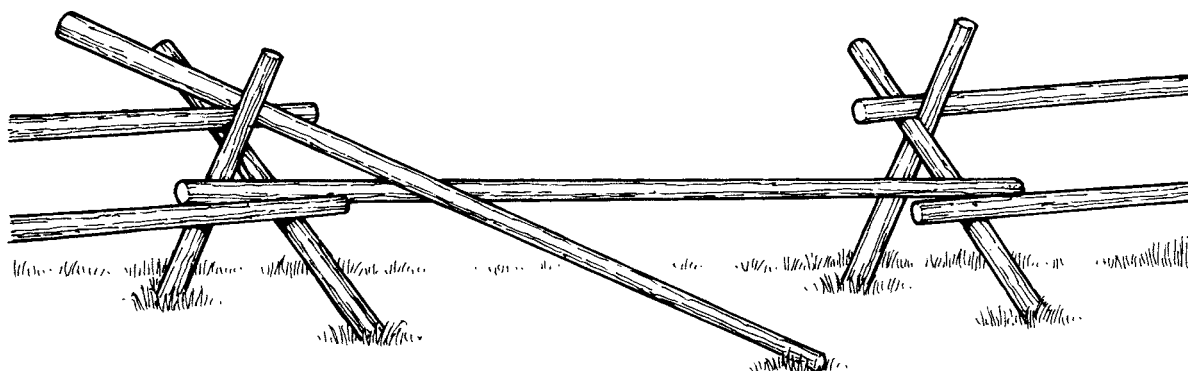

One-way Gate

Some highway departments have successfully used one-way gates to allow animals to escape a fenced right-of-way, but prevent them from re-entering. This design is used with tall enclosure fence, and requires some manufacturing. The gate is constructed with formed poles or tines on spring-loaded hinges, which allow animals only one direction of travel. The gate should be placed in a funnel or corner to guide the animals out.

Some large animals can bend the tines when trying to push through from outside the gate. To reduce injury, the tines may be curved back on themselves, but animals sometimes tangle their legs in the curved tines. Instead, it is now recommended to install plastic disks or balls on the ends of tines to prevent injury (Huijser et al. 2015).



Edmund Fogels

ONE-WAY FENCE GATE

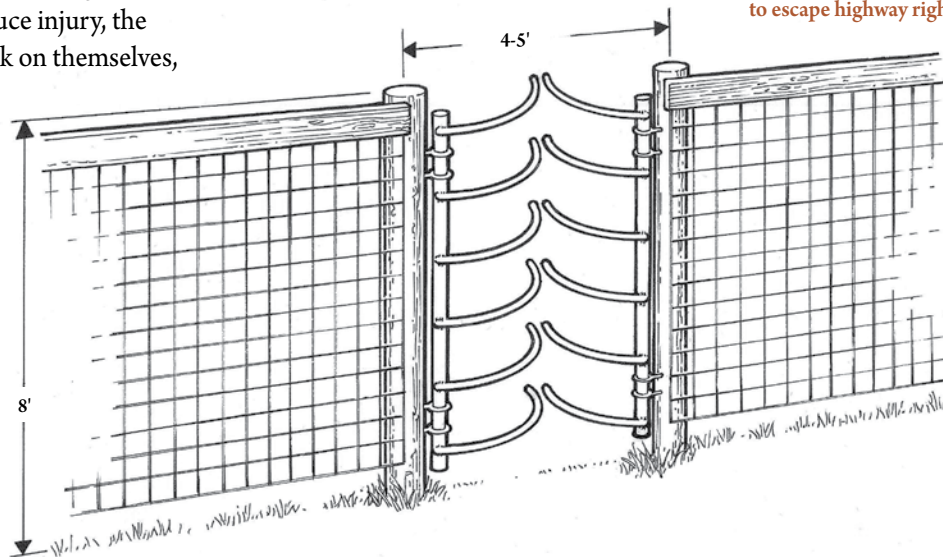

One-way fence gates are used in some areas to allow moose, elk, deer and other animals to escape highway right-of-ways.

Don't Forget the Humans

Consider installing fence crossings for people, especially if the fence is on or adjacent to public lands, or if you allow public hunting on your property. It will help preserve your fence and promote goodwill. Gates are one obvious choice, although gates are sometimes left open inadvertently. Two other styles keep the fence secure, and are easily installed: a wooden ladder over a fence or a v-gate that prevents livestock from squeezing through but allows humans and smaller animals to pass.

A V-gate or fence ladder will allow humans on foot to cross easily, without the risk a gate will be left open inadvertently.



Christine Paige



Christine Paige

FENCE SOLUTIONS PUT TO THE TEST

Collaboration Promotes Stewardship in a Checkerboard Landscape

The world's largest trona mine, operated by Tronox Alkali west of Green River, Wyoming, is completely surrounded by an expansive sagebrush rangeland and an extensive checkerboard of private and public ownership.

This rolling sagebrush country is core habitat for sage-grouse and key winter range for migrating pronghorn and mule deer. It is also sheep country, where horsemen herd their bands across the range and protect their sheep with Great Pyrenees guard dogs. In addition to trona (a mineral used to manufacture soda ash, which in turn is used to create glass, paper, detergents and other products), the region is rich with oil, natural gas, and coal. How can industry co-exist in this landscape with agriculture and wildlife?

Tronox Alkali decided that business and wildlife stewardship could be compatible goals. They partnered with a local and diverse group of agriculturists, landowners and agencies on a number of conservation projects to reduce the mine's footprint, enhance wildlife habitat, and contribute to wildlife research and monitoring.



Tronox Alkali

Near Green River, Wyoming, Ethen Garret marks fence for sage-grouse for his Eagle Scout project (above). Tronox Alkali brought local ranchers, service groups and agencies together to modify miles of fence for wildlife.

From 2013 to 2015, Tronox Alkali and their partners began to replace miles of woven sheep fence with a 4-strand wire fence friendlier to wildlife. Woven wire fence can completely block wildlife movement, especially for pronghorn and other species that can't or don't like to jump fences. The new fences were installed with three barbed wires at 40", 28" and 22" above ground level, and 12" between the top and second wire to prevent jumping animals from tangling legs. The bottom wire is smooth and set

at 16", the minimum for pronghorn to be able to slip underneath. Although it's a 4-strand wire fence, the local herders find it's adequate to control sheep.

To enhance some of the fence for sage-grouse, Ethen Garrett, an Eagle Scout from Troop 85, partnered with the BLM to install fence markers as his service project. The markers make the fence more visible to grouse as they fly low over the sagebrush, and have been shown to dramatically reduce grouse mortality. Ethen manufactured the reflective markers, making hundreds of extras for future BLM use, and recruited a crew to help install the markers along two miles of fence.

"This is truly collaborative work," reports Julie Lutz, Environmental Engineer for Tronox Alkali. "It's a multi-year project, with a target of 20 miles of new fence." Project partners include the Rock Springs Grazing Association, Uinta Development, the Rock Springs and Kemmerer BLM field offices, Wyoming Conservation Corps, Wyoming Game and Fish, and Seedskanie National Wildlife Refuge.

Photo: Tronox Alkali



Remedies for Existing Fences

How can you make existing fences more wildlife friendly?

Fence maintenance, modifications and removal can all help wildlife.

You can modify nearly any existing fence to be friendlier for wildlife. If you do not plan to completely replace an existing fence, you can alter individual sections to wildlife friendly standards to create crossings and easier passage.



Scott Nicolarsen

Remedies for Existing Fence

Maintenance:

- Keep wires tight. Sagging wires and neglected fences create a hazard for both domestic animals and wildlife. Loose wires can snare animals as they attempt to cross – tight wires reduce the chance of entanglement.

Modifications:

- Replace barbed wire with smooth wire, particularly for top and bottom strands. Smooth wire reduces the chance of animals getting snared on barbs and fatally entangled.
- Adjust the height of top wire: preferably no more than 40" and a maximum of 42" above the ground.
- Increase the distance between the top two wires to 12" to reduce entanglements.

- Reduce the number of wires to three, or at most four.
- Add a top rail, high visibility top wire, a PVC cover on the top wire, or flagging to increase visibility and prevent collision or entanglement.
- Raise the bottom wire to at least 16" and preferably 18" above the ground to allow animals to slip under.
- In selected fence sections, raise the bottom wire to the level of the third wire and secure with a staple lock.
- For pronghorn, gather bottom wires in a PVC pipe to create a "goat bar" underpass.
- Add wildlife crossings where wildlife trails cross fences by using dropped wires, dropped rails, lay-down fence or underpasses, as described earlier.
- When livestock aren't present, secure gates open to allow free passage for wildlife.

- Provide wildlife access to rivers, streams, wetlands and water holes, and through seasonal migration areas.

Removal:

- Remove old fences that are in disrepair or no longer in use. Remove any unnecessary interior fences.
- Bale and carry away piles of wire. Some recycling centers will recycle old wire. Never leave wire on the ground.
- Many volunteer groups are interested in helping with fence removal projects to help wildlife, such as local chapters of sportsman's groups, scout troops, 4-H and others.



Wildlife "Death Pipes"

Open vertical pipes are silent and overlooked killers of birds and small animals. Hollow metal and plastic (PVC) pipes serve a wide variety of purposes, from ventilation pipes for buildings, outhouses or irrigation systems, to fence posts, corner posts, gate uprights and mining claim markers.

Birds, small mammals and reptiles will investigate hollow pipes, especially for potential nest sites. Once inside they become fatally trapped, unable to find purchase on the pipe's smooth walls. In 2009, for example, a biologist at the Audubon California Kern River Preserve found more than 200 dead birds in a fallen 50-year-old irrigation standpipe.

Most of the victims are cavity-nesting birds, such as bluebirds, woodpeckers, kestrels and small owls. Because open pipes are so prevalent across our landscapes, the overall toll on birds and small animals may be in the millions.

Easy Fixes for Death Pipes

- Remove unused obsolete pipes.
- Permanently cap or fill pipes used as fence posts, gate uprights, sign posts, claim markers or monuments. These can be capped with concrete, or entirely filled with sand, gravel or concrete. Chain link fence posts can be capped with commercial caps.
- Cover ventilation pipes on buildings, irrigation systems and outhouses with galvanized hardware cloth held in place by steel pipe clamps, or install commercial vent caps.



Sean Rowe

CAPPING OR SCREENING
OPEN VERTICAL PIPES
PREVENTS BIRDS AND
OTHER SMALL ANIMALS
FROM BECOMING
FATALLY TRAPPED.



Sean Rowe



Sean Rowe



Sean Rowe



Residential Fences

Fences serve many functions around homes, both aesthetic and practical: they may define a boundary, create a play space, contain pets or discourage wildlife from yards and gardens.

Avoid fences with spikes, pickets or barbs that protrude above the top bar. Many wrought iron fence designs have decorative spikes on top. Gauging a jump by the uppermost horizontal bar, animals can misjudge the fence height and be lethally caught or impaled on the fence.

Any tall residential fence, whether wrought iron, plank, picket or chain-link, should be used only for small areas around the home, and not for larger perimeter fences. If a fence provides a complete barrier, an open gate may allow animals to find a way in but not out. Be sure vertical planks or bars are spaced closely enough that animals will not try to push through and become trapped. Check city and county ordinances for fence regulations.

Many residential areas are in wildlife winter range. Using landscaping instead of fencing, or using only low, very permeable fences, allows wildlife to move freely through neighborhoods.



Christine Paige



Christine Paige



Christine Paige

Above: A solid top rail and narrow vertical bars on this iron fence reduce hazards to wildlife.



Courtesy of International Chimney Corp. and The Forest Lawn Group

Deer can be impaled on spiked fences, as happened for this whitetail in Colorado (right). The Williamsville Cemetery in New York found a practical solution to shield the spikes on their historic fence (above).



Colorado Parks and Wildlife file photo



Fence Alternatives

Hedgerows

If you do not need a fence to contain or exclude livestock, consider other creative ways to define boundaries and discourage trespass.

A line of shrubs or trees can mark a boundary line, beautify your landscape, and provide nest sites for birds and food and cover for wildlife. Depending on the site, a wide range of native and ornamental shrub species can be used to create an effective hedgerow – from lilacs and honeysuckle to willows, alder and big sagebrush. Your County Cooperative Extension Office can help you find local sources for plants and choose appropriate species for your site.

Many native shrubs are suitable for hedges and enhance wildlife habitat.

HEDGEROW



Beware using some non-native species that can become difficult or impossible to manage.

Mix it up: consider using several species, varying the width of the

hedgerow, or using plants of different heights to create a natural and wildlife friendly hedge. Once established, hedgerows require minimal maintenance unless you want a highly manicured look.



Boundary Markers

Where you do not need a fence, consider marking property boundaries with signs, flexible fiberglass or plastic boundary posts, or fence posts spaced at intervals but without cross wires.

Property boundaries can also be marked with steel t-posts or flexible fiberglass or plastic posts such as Carsonite or Flexstake posts, available through survey and forestry suppliers. Commercial fiberglass and plastic marker posts are highly visible and durable. However the cost per post can be greater than a heavy-duty steel fencing t-post.

Barrier Posts

Barrier posts or bollards are short stout posts spaced to prevent access by vehicles. They can be used to define a driveway or parking area, or edge an expanse of lawn. Posts can be spaced closely together, or placed farther apart and connected with a heavy chain, cable or rail, from two to three feet high. Bollards and posts with low chains or rails pose little deterrent or hazard for wildlife.

Bollards can be made of wood, concrete, brick, stone, cast iron, aluminum, or steel; a row of boulders serves the same function. Some can be installed as fixed or removable posts. A wide variety of bollard designs and ornamental covers are also available commercially.



Above: A low post and single cable or chain fence creates little hazard to wildlife if it can be easily seen.

Right: Posts can mark a boundary where a fence is not needed. Flexible plastic posts can be ordered with reflective tape or custom lettering.

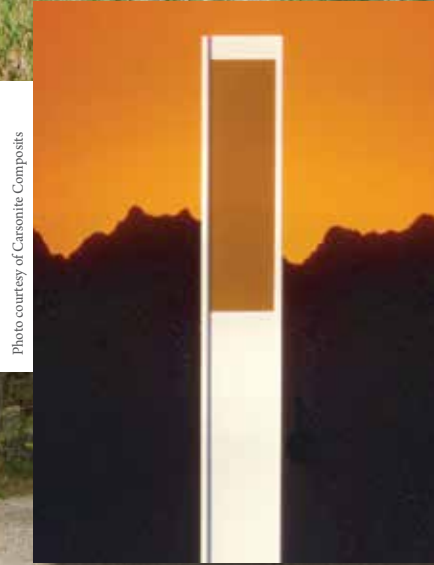

Photo courtesy of Carsonite Composites



A row of boulders or bollards (concrete or wooden posts) can prevent vehicle access but pose no barrier to wildlife.



Christine Paige

Christine Paige

Christine Paige



If You Must Exclude

There are times when exclusion fence to keep wildlife out is necessary.

If you must put up an exclusion fence, avoid fencing a large area that includes wildlife habitat. Focus exclusion fences on small areas for specific purposes, such as fencing around play areas, vegetable gardens, beehives, calving and lambing areas, or haystacks. Keep exclusion fence close to the activity you need protected, and allow wildlife to use other parts of the property.

For any exclusion fence, place gates at corners: an animal that inadvertently finds itself trapped inside is more likely to find escape through an open corner gate than through a side gate.



Christine Paige

Use chainlink fences only for specific purposes, such as play areas and dog kennels.

Wooden Plank Fence and Chainlink Fence

Chainlink fences and wooden fences with closely-spaced vertical planks are especially unfriendly to wildlife and can create a complete barrier to animals of all sizes, from turtles to moose. If you must use chainlink or plank fences, limit their use to small enclosures.

Yard fences and play area fences often do not need to be more than 4' high. If higher, be sure gates are kept secured to prevent animals from finding their way in.

For small chainlink dog kennels, attach a roof to prevent wild animals from becoming trapped inside. A roof also provides shade and shelter for your pets.



Christine Paige

Deer and Elk Exclusion Fence

A permanent non-electric exclusion fence for deer and elk should be 7' to 8' high. A 7' to 8' wooden fence that animals can't see through is typically used around housing areas. For gardens, vineyards and other agricultural plots, 8' woven wire fence is more often used with posts set at 8' to 20' intervals, and the wire is brought tight to the ground. Make the top highly visible by using a top rail, high-visibility wire or flagging. Place gates at corners, where an accidentally trapped animal is more likely to find an escape.

A 7' to 8' fence is an effective barrier to elk, but should be used only for specific needs, such as gardens or haystack yards. Make the top highly visible with flagging, white tape or wire, or a rail.

Haystacks and Hay Yards

Several options exist for protecting haystacks from wildlife damage. These include electric, non-electric, temporary and permanent designs.



Montana Fish, Wildlife & Parks

Deer-D-Fence

A traditional 8' woven wire fence can protect a stackyard from game damage. An alternative is a permanent 7-strand electric fence.

Temporary Solutions

A simple and cost-effective solution is to wrap haystacks with heavy-duty plastic mesh netting, such as Deer-D-Fence, a 2x2" durable plastic mesh that is strong, lightweight and easy to handle. Haystacks and large bales can be wrapped quickly, and the netting is readily lifted off when not needed. This netting is especially useful for temporary applications, rapid installation, and remote settings.

Plastic netting can also be used as fencing instead of woven wire, and installed on wood or steel posts using UV-resistant zip-ties. The plastic is UV-resistant and durable, and materials cost is comparable to woven wire. However labor costs for fence construction can be greater than with traditional materials.

Increase visibility by adding poly-coated wire, tape or flagging when using plastic mesh as fencing. Although the mesh would cause little harm to most

large animals, it is nearly invisible when erected and should be flagged to be visible to birds.

Permanent Fences

Many landowners prefer to protect a large haystack yard with a permanent fence. The traditional stackyard fence is at least 8' high and uses woven wire with wood posts or a combination of wood and steel posts. One-way gates should be placed in the corners to allow animals that might be inadvertently trapped inside to find a way out more easily.

A permanent electric fence, 6' to 7' high, is also effective for protecting stackyards from game damage. This fence is constructed with high-tensile smooth wire spaced at 10" intervals with alternating hot and grounded wires.

A 7-wire fence 72" high with strands at 10" intervals is adequate for elk. Deer, on the other hand, require a higher fence of 84", with 8 to 9 wires.



Christine Paige



Montana Fish, Wildlife & Parks

Haystack Fence

- Use 10' pressure-treated wooden line posts, 3" to 4" in diameter, driven 2.5' into the ground, and spaced at 30' intervals.
- Use 10' pressure-treated wooden brace posts, 4" to 5" in diameter, driven 3' into the ground.
- Use 12.5 gauge, smooth Class III galvanized wire with a tensile strength of 170,000 PSI and breaking strength of 1308 lbs. To increase visibility, use white poly-coated wire with the same specifications.
- Space seven strands at 10" intervals; the top wire at 72" for elk or 84" for deer; wooden posts require using insulators.
- Alternate hot and ground wires: bottom wire is grounded and top two wires are hot.
- Place solar energizer according to manufacturer recommendations.
- Ground fence properly according to the energizer instructions.
- Install electric fence warning signs.



Joe Weigand, Montana Fish, Wildlife & Parks

A permanent electric fence is an effective alternative to woven wire fence. A 6' fence with 7 strands at 10" intervals is adequate for elk.

If You Must Exclude

Wire Mesh Cages to Protect Trees from Beaver

The simplest method to prevent beaver from harvesting trees is to install a cylindrical mesh cage around tree trunks. Heavy-gauge rolled hardware cloth or mesh fencing is available from most ranch supply and hardware stores.

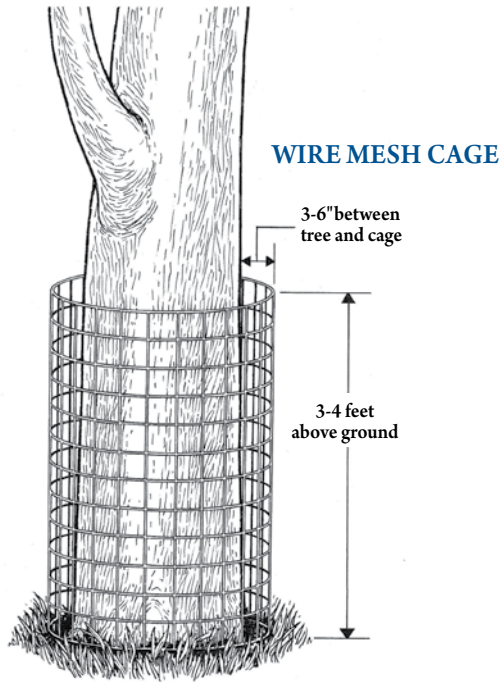

Debo Hoddiford

Wire Mesh Cage

- Use heavy woven or welded wire mesh fencing (e.g., 6 gauge) to prevent beaver from chewing through. Chicken wire is **not** effective.
- Mesh size should be 4" x 4", 2" x 2" or smaller—small enough to prevent beavers from squeezing through or getting tangled.
- Leave a 3" to 6" gap between the tree and cage to allow for tree growth.
- The cage should extend 3 to 4 feet above the ground or **above the potential snow line**.



Photo: www.arniebroking.photo



Deterring Predators

A variety of permanent and temporary electric fence designs can deter large predators. These fences are used primarily for small-scale operations, such as beehives, dumpsters, lambing or calving areas, corrals, bone piles and other small areas in need of protection from scavenging or predation.

A 7-wire permanent electric fence from 42" to 54" high is most commonly used to deter bears and wolves. In special situations, a higher 9-wire or 11-wire fence might be used. In the typically dry, rocky soils in our region, the fence should have alternating charged and grounded wires, with both top and bottom wires hot. In this setup, an animal must touch both a hot and a ground wire to receive a full shock. Use a grounded bottom wire if the wire is likely to touch vegetation. A fence with all hot wires can be used in areas with damp or moist soil that will provide sufficient grounding when the animal touches a hot wire.

The table at right shows specifications developed by the NRCS in cooperation with Montana Fish, Wildlife and Parks (NRCS 2006b). *(continued)*



Seth Wilson

Predator deterrent fencing should be used only around specific areas, such as corrals and beehives. Always hang warning signs on electric fences.



Seth Wilson

Bear and Wolf Deterrent Fencing

(Adapted from NRCS 2006B)

Charge and Recommended Wire Heights from Ground Level

	Bear ¹ 7-wire	Bear & Wolf ² 7-wire	Beehive or Chicken Coop ³ 7-wire	Wolf & Bear ⁴ 9-wire (corral or home areas)	Wolf & Bear ⁴ 11-wire (away from corral or home areas)
Top wire	(+) 42"	(+) 54"	(+) 54"	(+) 60"	(+) 72"
2nd wire	(-) 36"	(-) 42"	(-) 42"	(-) 50"	(-) 64"
3rd wire	(+) 30"	(+) 32"	(+) 32"	(+) 42"	(+) 56"
4th wire	(-) 24"	(-) 24"	(-) 24"	(-) 36"	(-) 48"
5th wire	(+) 18"	(+) 18"	(+) 18"	(+) 30"	(+) 40"
6th wire	(-) 12"	(-) 12"	(-) 12"	(-) 24"	(-) 32"
7th wire	(+) 6"	(+) 6"	(+) 6"	(+) 18"	(+) 26"
8th wire				(-) 12"	(-) 20"
9th wire				(+) 6"	(+) 15"
10th wire					(-) 10"
11th wire					(+) 6"

Bear¹ (42") 7-wire: Primary use is to deter grizzly and black bears; allows deer and elk passage.

Bear & Wolf² (54") 7-wire: Primary use is to deter grizzly, black bear and wolves from calving and lambing areas, but where wolf activity is low to moderate or there is potential for wolf activity.

Beehive or Chicken Coop³ (54") 7-wire: Primary use is to deter grizzly and black bears from apiaries.

Wolf & Bear⁴ (60-72") 9- or 11-wire: Primary use is to deter wolves and bears when predator activity or risk is high.

Also useful for situations where ungulate damage to a lower fence (54") might be anticipated, or there is a predator issue.



© Henry H. Holdsworth/wildbynaturegallery.com

Deterring Predators



© Henry H. Holdsworth/wildbynaturegallery.com

Deterring Predators (continued)

Key to the success of electric fences is to erect them before the attractant level is high, so that animals are “trained” to a fence early on. **Also, the amount of energy your setup can deliver over the full distance of the fence is crucial.** Because of predators’ thick fur, the system must deliver enough shock to deter them. For grizzlies, the system should deliver 6,000 volts or more, and will require an energizer with a rating of at least 0.7 joules. Be sure your energizer can deliver adequate power over the distance you need. Vegetation touching the wires and other situations can cause energy leakage. Regularly check the

voltage on every hot wire with a high-quality voltage tester, especially midway and at the farthest distance from the energizer. In addition, **always install warning signs on the fence.**

For more complete instructions and appropriate designs, see *Bears and Electric Fencing* published by Montana Fish, Wildlife and Parks, available online at <http://fwp.mt.gov/fishAndWildlife/livingWithWildlife/beBearAware/bearAwareTools.html> (Annis 2010). Also see *Practical Electric Fencing Resource Guide: Controlling Predators* published by the Living with Wildlife Foundation and available online at <http://www.lwwf.org> (Thompson, et al. 2005).

Fladry to Deter Wolves

Fladry is a line of wire strung with long flags or streamers and used to deter predators from livestock. Fladry’s advantage is that it is portable, temporary, and requires comparatively little planning – it serves best as a short term deterrent until a more permanent fence can be planned and installed.



Steve Primm



Tim Manley

Chicken coops and beehives are irresistible to bears, but a high-energy electric fence is effective protection.



Steve Primm



© Henry H. Holdsworth/wildbynaturegallery.com



Steve Primm



Deployed around temporary pastures, fladry has been shown to deter wolves for up to 60 days, and much longer if electrified. Be aware that this technique can have considerable problems with deployment, tangling, voltage leaks, general availability, and high initial capital and labor costs. However, because it is portable and temporary, a number of western ranchers have found it to be an effective tool to protect livestock from wolves (Primm and Robinson 2011.)

Fladry

- Use a large spool or reel (6" minimum diameter and 11" minimum width) to coil and deploy fladry. Handling by hand is enormously time-consuming.
- Electrified fladry ("turbo fladry") has a longer period of effectiveness, and deters livestock from trampling the line.
- Use $\frac{3}{8}$ " x 4' fiberglass rod posts. Carry these in an old golf bag to deploy in the field.
- Line height should be no higher than 28," and fladry flags should hang above the ground. In spring and summer it is difficult to keep flags from touching vegetation.
- To secure the line, use a "harp clip," which allows the fladry flags to slide through the clip. See <http://www.premier1supplies.com> for an effective harp clip.
- For anchor posts, use thicker composite posts with wire clips, steel t-posts with insulators, or insulators on permanent wooden posts of existing fence.
- Create gates using anchor posts and good quality electric fence handles connected to an eye-bolt on the post.
- Electrify with an energizer that will provide an output of at least one joule per mile of fladry.
- A "wide impedance" energizer will deliver more consistent voltage under adverse conditions, such as dry soils, dry snow, cold temperatures, and long insulating fur.



Getting Help

People and organizations like hands-on projects that enhance habitat for wildlife. Many local land trusts, sportsmen's clubs, community groups and conservation organizations may be able to provide cost-share support or volunteers for wildlife friendly fencing projects to enhance wildlife habitat on private or public lands. As an example, in Teton County, the Jackson Hole Wildlife Foundation (www.jhwildlife.org) has a dedicated volunteer group that works on fence removal and fence modification projects for wildlife. Scouts, 4H groups, school classes and Americorps members have also pitched in as volunteers on cooperative projects.

Check with your local County Cooperative Extension Office for technical assistance and information on landowner programs (for contact information, go to <http://www.uwyo.edu/uwe/county/>). Your local Conservation District may also have grants and resources available to help with fence projects that provide a public benefit by enhancing wildlife resources (<http://www.conservewy.com/>). Wyoming Game and Fish may be able to assist on some projects, especially those in wildlife migration areas (<https://wgfd.wyo.gov/>).

The Natural Resources Conservation Service (NRCS) works on a voluntary basis with private landowners across the U.S. and offers cooperative programs to enhance natural resources, including improvements to wildlife habitat. NRCS can provide technical and financial assistance for many types of projects, including new wildlife friendly fencing and retrofitting existing fence to become more wildlife friendly. Their primary focus is on addressing resource concerns on private land, however some of their programs can be used on federal or state lands as well. See <http://www.wy.nrcs.usda.gov> to learn more about the NRCS

and contact information for your local NRCS Field Office.

The Bureau of Land Management and US Forest Service advocate using wildlife friendly fence. If you share a boundary with federal lands or lease a federal grazing allotment, contact the agency's local office to inquire about opportunities to replace or modify fences to be wildlife friendly.



Mark Gocke



Scott Nicolarsen

Many land trusts, sportsmen's clubs, community groups and conservation organizations may be able to help with technical assistance, staff support and small grants on wildlife friendly projects.



Mark Gocke



Sources

- Allen, G.T. and P. Ramirez. 1990.** A review of bird deaths on barbed wire fences. *Wilson Bulletin* 102(3)553-558.
- Annis, K. 2010.** Bears and Electric Fencing: A starter's guide for using electric fencing to deter bears. Montana Fish, Wildlife and Parks. 12 pp. Available online at: <http://fwp.mt.gov/fishAndWildlife/living-WithWildlife/beBearAware/bearAwareTools.html>.
- Christiansen, T. 2009.** Fence marking to reduce greater sage-grouse (*Centrocercus urophasianus*) collisions and mortality near Farson, Wyoming – summary of interim results. Wyoming Game and Fish Department, Green River, WY. 3 pp.
- Colorado Division of Wildlife. 2007.** Fencing with wildlife in mind: understanding the impact on wildlife when fencing your property. Colorado Division of Wildlife, Living With Wildlife Program. Brochure, 9 pp. Available online at: <http://wildlife.state.co.us/NR/rdonlyres/B0D65D61-6CB0-4746-94F1-6EE194E1C230/0/fencing.pdf>.
- Ehmke, C. 2009.** If You Fence It, They'll Stay out: Fencing Out Stock in Wyoming. Univ. Wyoming Cooperative Extension Service. 2pp. Available online at: <http://uwadmnweb.uwyo.edu/CESFRM/IfYouFenceIt.pdf>.
- George Miksch Sutton Avian Research Center. 2006.** Fence marking for lesser prairie-chickens: a cooperative conservation solution. Sutton Avian Research Center, Bartlesville, OK. 2 pp. Available online at: http://www.suttoncenter.org/fence_marking.html.
- Gillihan, S.W. 2000.** Barbed wire fence fatal to burrowing owl. *J. Colorado Field Ornithologists*. 34(4)220-221.
- Harrington, J.L. 2005.** Characteristics of ungulate behavior and mortality associated with wire fences. Master's thesis, Utah State University, Logan, UT. 48 pp.
- Harrington, J.L., and M.R. Conover. 2006.** Characteristics of ungulate behavior and mortality associated with wire fences. *Wildlife Society Bulletin* 34(5)1295-1305.
- Huijser, M., A. Kociolek, T. Allen, P. McGowen, P. Cramer, R. Venner. 2015.** Construction guidelines for wildlife fencing and associated escape and lateral access control measures. Western Transportation Institute, Montana State Univ., Bozeman, MT. 218 pp.
- Jones, P.F., B. Seward, L. Seward and H.M. Dorchak. 2012.** Opening up the prairies: evaluating the use of goat bars by pronghorn. Pp. 52-58 in Walker, R. N., and K. W. Rodden, eds. Proceedings of the Twenty-fifth Biennial Western States and Provinces Pronghorn Workshop. New Mexico Department of Game and Fish, Santa Fe, USA.
- Karhu, R. and S. Anderson. 2003.** Evaluation of high tensile electric fence designs on big game movements and livestock containment. Final Report April 2003. Wyoming Cooperative Fish and Wildlife Research Unit. Laramie, WY. 27 pp.
- Karhu, R. and S. Anderson. 2006.** The effect of high-tensile electric fence designs on big-game and livestock movements. *Wildlife Society Bulletin* 34(2)293-299.
- Karsky, Dick. 1988.** Fences. Publication #8824 2803. U.S. Department of Agriculture, Forest Service, Missoula Technology and Development Center, Missoula, MT. 210 pp. Second printing 1999. Available online at: <http://www.fs.fed.us/eng/pubs/pdfpubs/pdf88242803/pdf88242803dpi300.pdf>.
- Montana Dept. of Fish, Wildlife and Parks. 2002.** Fencing specifications for FWP properties. Internal document. 4 pp. MT Dept. of Fish, Wildlife and Parks, Helena, MT. October 25, 2002.
- Nero, R.W. 1974.** Great gray owl impaled on barbed wire. *Blue Jay* 32(3)178-179.
- Nesbitt, S.A. and D.T. Gilbert. 1976.** Powerlines and fences hazards to birds. *The Florida Naturalist*. April: 23.
- North Dakota Game and Fish Dept. 2006.** Pronghorn management guide-2006: Biological and management principles and practices designed to sustain pronghorn populations from Canada to Mexico. North Dakota Game and Fish Department. 158 pp. Available online at: <http://gf.nd.gov/multimedia/pubs/prong-mgmt-guide-pdf-ndx.html>
- NRCS. 2006a.** Natural Resources Conservation Service Conservation Practice Specification: Permanent Power Fence. Code 382(b)-1of 5. May 2006. Natural Resources Conservation Service, Wyoming. 7 pp.
- NRCS. 2006b.** Natural Resources Conservation Service General Specification Power Fence. Fence (Feet) Code 382. Specification MT-382 (Power Fence), April 2006. 3 pp. Natural Resources Conservation Service Montana. Available online at: http://efotg.nrcs.usda.gov/references/public/MT/382_spec_Power_2006.pdf.
- NRCS. 2010.** Animal Enhancement Activity – ANM27 – Wildlife friendly fencing. Natural Resources Conservation Service. 2 pp.
- Patla, S. and D. Lockman. 2004.** Considerations and prescriptions for the design, construction and management of shallow water wetlands for spring through fall use by trumpeter swans (*Cygnus buccinator*) in western Wyoming. Report, Nov. 2004. Wyoming Game and Fish Department, Jackson, WY and Wildlife Services of the Rockies, Cheyenne, WY. 9 pp.
- Pollock, M.M., G. Lewallen, K. Woodruff, C.E. Jordan and J.M. Castro, editors. 2015.** The Beaver Restoration Guidebook: Working with Beaver to Restore Streams, Wetlands, and Floodplains. Version 1.02. United States Fish and Wildlife Service, Portland, Oregon. 189 pp.
- Primm, S. and A. Robinson. 2011.** Electrified fladry for deterrence of gray wolves (*Canis lupus*): an evolving manual of best practices. People & Carnivores Program, Northern Rockies Conservation Cooperative & Sun Ranch Institute. 15 pp. Available online at: <http://peopleandcarnivores.org/>.
- Quitmeyer, C.J., J.A. Bopp, R.M. Stephens, R. Karhu and S. Anderson. 2004.** High tensile electric fence: phase 2 – liability issues, maintenance costs, and containment of bison. Final Report December 2004. Wyoming Cooperative Fish and Wildlife Research Unit. Laramie, WY. 85 pp.
- Schmidt, L. and J. Knight. 2000.** Electric fencing to control deer and elk on Montana's farms and ranches. Montana State University Extension Service. 4 pp. Available online at: www.co.yellowstone.mt.gov/extension/ag/pubs/mt200010.pdf.html.
- Sheldon, D.P. 2005.** Movement and distribution patterns of pronghorn in relation to roads and fences in Southwestern Wyoming. Master's thesis, Department of Zoology and Physiology, University of Wyoming, Laramie, WY. 140 pp.
- Stevens, B.S. 2011.** Impacts of fence on greater sage-grouse in Idaho: collision, mitigation and spatial ecology. Master's thesis, College of Graduate Studies, University of Idaho, Moscow, ID. 210 pp.
- Stevens, B.S., J.W. Connelly and K.P. Reese. 2012a.** Multi-scale assessment of greater sage-grouse fence collision as a function of site and broad scale factors. *J. Wildlife Management*. doi: 10.1002/jwmg.397
- Stevens, B.S., K.P. Reese, J.W. Connelly, and D.D. Musil. 2012b.** Greater sage-grouse and fences: Does marking reduce collisions?. *Wildlife Society Bulletin*. doi: 10.1002/wsb.142.
- Thompson, S., J. Jonkel and P. Sowka. 2005.** 2005 Edition Living with Predators Guide. Practical Electric Fencing Resource Guide: Controlling Predators. Living With Wildlife Foundation, Swan Valley, MT. 38 pp. Available online at: <http://www.lwwf.org>.
- Washington Dept. of Fish and Wildlife. 2004.** Make your fence wildlife friendly. *Crossing Paths Newsletter*, Fall 2004.
- Wolfe, D.H., M.A. Patten, and S.K. Sherrod. 2009.** Reducing Grouse Collision Mortality by Marking fences (Oklahoma). *Ecological Restoration* 27(2)141-143.
- Wyoming Statutes. 2007.** Wyo. Stat. Ann. §§11-28-101–11-28-108 (2007).
- Wyoming Statutes. 2007.** Wyo. Stat. Ann. §6-3-303 (2007).
- Wyoming Game and Fish Dept. 2004.** Fencing guidelines for wildlife. Revised version. Habitat Extension Bulletin No. 53. Wyoming Game and Fish Dept. 12 pp.
- Wyoming Livestock Board. 2011.** Title 11 - Agriculture, livestock and other animals; Chapter 28 - Fences and cattle guards; Wyoming... "Fence In" or "Fence Out?" Available online at: <http://wlsb.state.wy.us/LE/fencelaw.htm>.
- Yoakum, J. D., P. F. Jones, J. Cancino, R. J. Guenzel, R. Seidler, A. Munguia-Vega, I. Cassaigne, and M. Culver. 2014.** Pronghorn management guides. Fifth edition. Western Association of Fish and Wildlife Agencies' Pronghorn Workshop and New Mexico Department of Game and Fish, Santa Ana Pueblo, New Mexico. 159 pp.



Kerry Singleton



www.grvlandtrust.org



www.wyomingwildlifeoundation.org



www.rayneswildlifefund.org



www.npca.org



www.tronox.com



www.westernlandownersalliance.org



www.sublettecd.com



wgfd.wyo.gov



www.jhwildlife.org



www.tetonconservation.org



www.wycf.org

This guide was made possible with the support of these partners, dedicated to conserving Wyoming's land, wildlife and agricultural heritage.